

48" and 52" Hyflo™ Fans Installation and Operators Instruction Manual

Thank You

The employees of Chore-Time Equipment would like to thank your for your recent Chore-Time purchase. If a problem should arise, your Chore-Time distributor can supply the necessary information to help you.



1747-002 04/03



1747-003 04/03

Fan and Fan Framing Dimensions

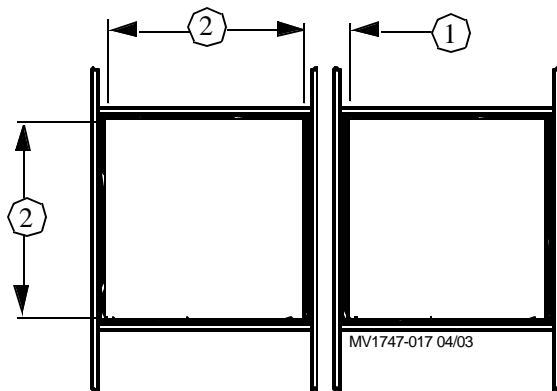
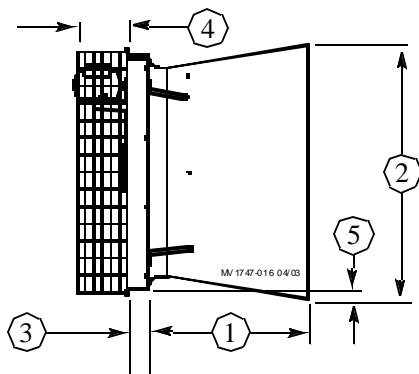

Item	48" Hyflo	52" Hyflo
1	41-7/8" [106.36 cm]	44" [111.76 cm]
2	59" [149.9 cm]	64" [162.56 cm]
3	5-1/8" [13.02 cm]	5-1/8" [13.02 cm]
4	11.5" [29.2 cm]	11.5" [29.2 cm]
5	2-5/16" [5.87 cm]	4-1/8" [10.48 cm]

Item	48" Hyflo	52" Hyflo
1	4" [10.16 cm] Minimum	8" [20.32 cm] Minimum
2	55" [139.7 cm]	56-1/2" [143.51 cm]

Planning the layout of the spacing between Fans is very important. Spacing too close together will cause interference between the discharge Cones. **The Rough Opening dimensions for Fans are shown above.**

Figure 1. Fan Dimensions

The Fan Inlet and exhaust must be kept clear of obstructions. Failure to keep the Fan airflow path clear of obstructions could cause loss of Fan performance and Fan damage.

Do Not operate these Fans with a variable speed control device. Operating static pressure should be less than 0.15 inches water column.

Fan Assembly/Installation

Remove the Fan from the Crate and Install into Wall opening. The Danger Decals should be located at the bottom of the Fan as **shown below**. In the holes at the side center locations Use 1 Lag Screw, 2 Nylon Washers, and 1 Screen Clip to attach the Fan to the wall (See **Figure 2**). These Screen Clips will later be used to hold the Screen on. Install Lag Screws in the remaining 6 locations as shown in **Figure 2**

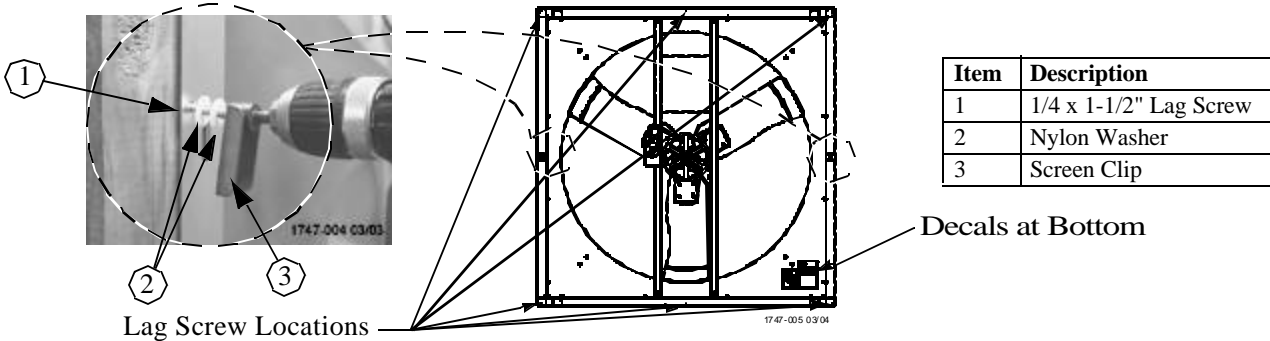

Figure 2. Installing Fan in Wall Opening

Motor Installation

Rotate the Motor Support Bracket into the upright position by removing the **Upper** Carriage Bolt and Nut and loosening the **Lower** Bolt and Nut (See **Figure 3**). Rotate the Motor Support Bracket until it is perpendicular to the Fan Posts and fasten with (4) 5/16 Carriage Bolts and (4) 5/16 Flange Nuts. *Note that the Nuts go outside the Posts.* Remove the Motor from the Crate and attach it to the Motor Support Bracket with (4) 5/16 Carriage Bolts and (4) 5/16 Flange Nuts **as shown**.

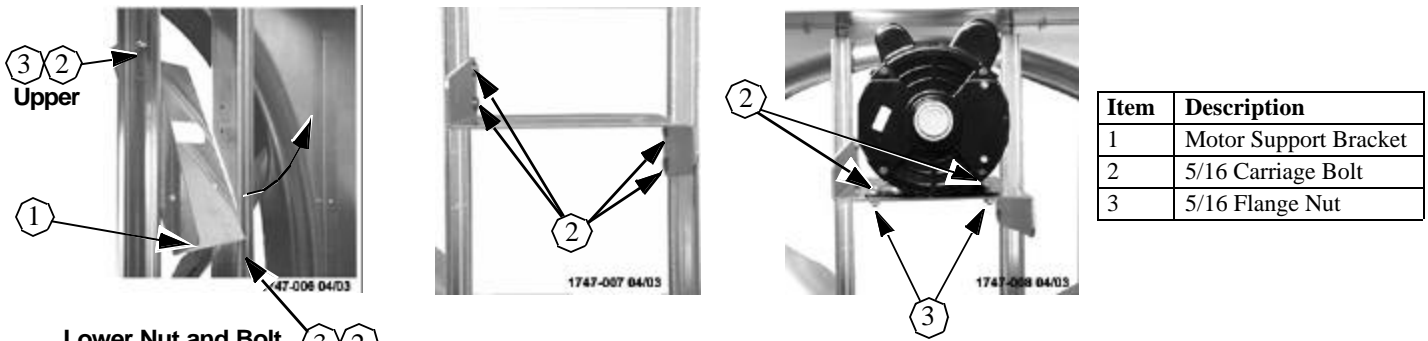

Figure 3. Attaching the Motor Support Bracket and Motor

Belt Installation

Guide the Belt through the Opening in the Motor Support Bracket and loop it over the Motor Sheave. Guide the Belt around the Tensioner Sheave and push on it to get enough slack to put the Belt on the Driven Sheave **as shown in Figure 4**. Make sure the Belt does not rub against the Motor Support Bracket.

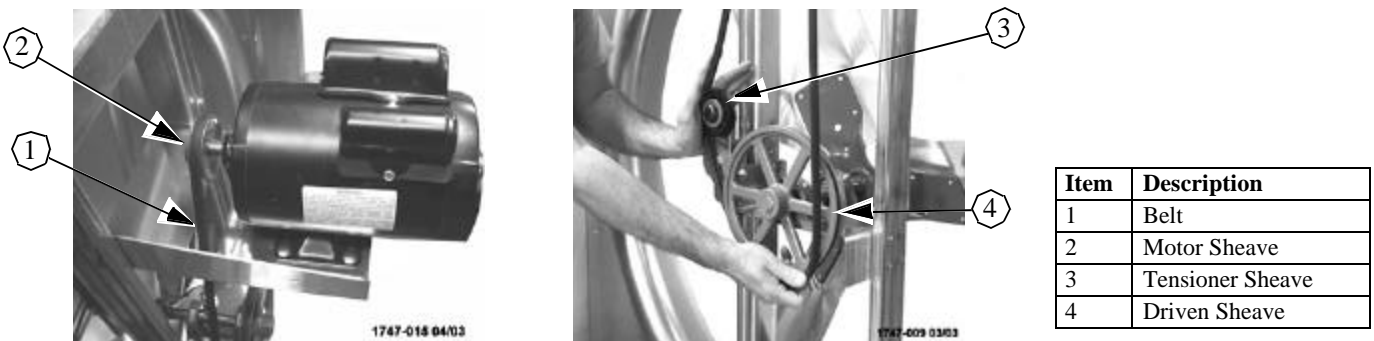
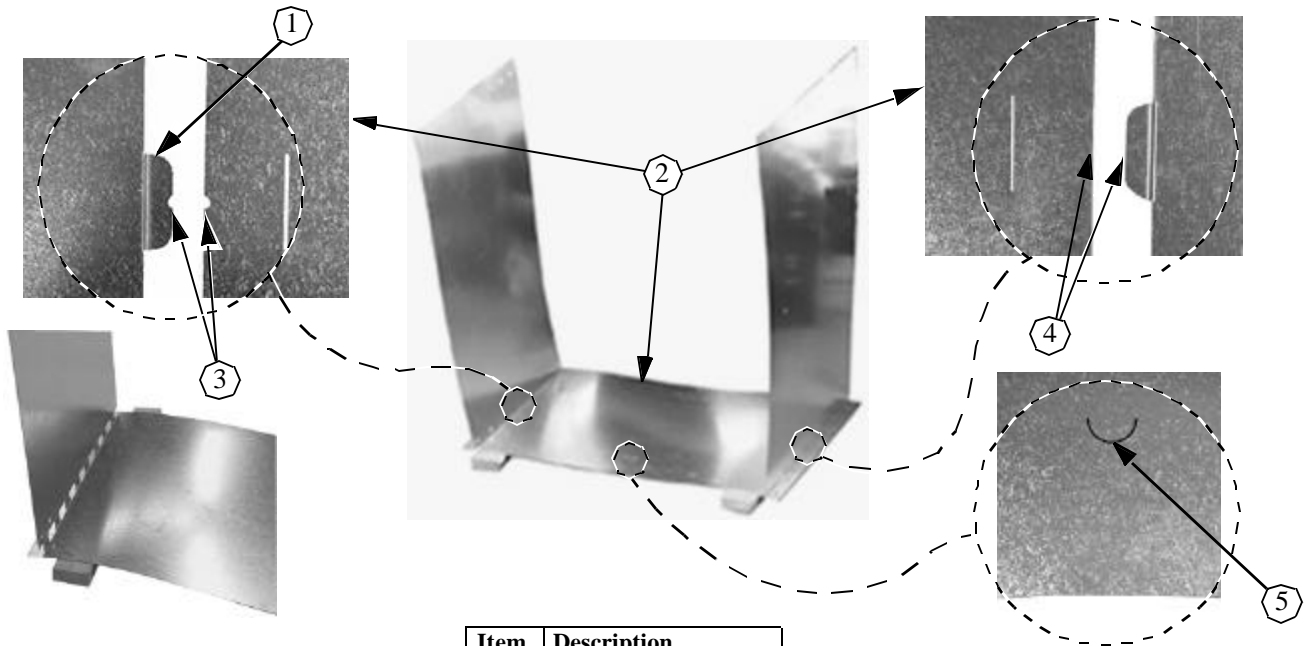

Figure 4. Installing the Belt

Cone Assembly

The Cone Panels can be identified by the number of notches at the edge of each Panel. Begin the Cone assembly by laying the Panel with **no tabs** on a couple of boards with the one notch end to the left and with the **Knock-out** at the Bottom as shown in Figure 6. Insert the tabs into the slots on the edge with the same number of notches.



Item	Description
1	Tab
2	Panel with No Tabs
3	1 Notch Panels
4	No Notch Panels
5	Knock-out

Figure 6. Assembling Cone Panels

When all four Cone Panels are connected stand the panels up on edge and curl the Cone around with the smaller diameter of the Cone up as **shown below**. Assemble the final Panels together and allow the Cone to take its shape. If the Cone is assembled correctly the Tabs should all be on the Inside of the finished Cone.

Fasten the Cone Panels together with (4) 5/16 x 1/2" Hex Bolts Threaded in from the inside of the finished Cone as shown in Figure 7.

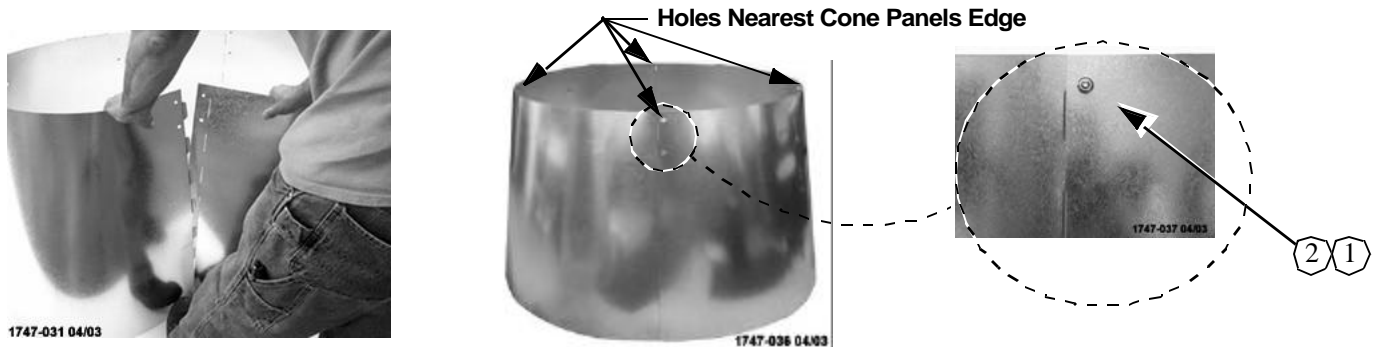

Item	Description
1	5/16 x 1/2" Bolt
2	5/16 Flange Nut

Figure 7. Bolting Cone Panels

Door Assembly/Installation

To install the Door in the Cone you must first identify the top of the Cone and the top of the Door. The bottom of the Cone Has a C-shaped cut-out in it that will later be used for a drainage knockout (See Figure 8). The top of the Door can be identified by the location of the Door Springs. The Spring attaches to the Post towards the top of the Door (See Figure 8). With the Door opening towards the ground, as shown below, line up the Four Holes in the Door Ring with the **second set** of holes from the edge of the Cone and thread (4) 5/16 x 1.25" Bolts in until they are tight. Do not install Nuts at this time. These Bolts will be used later to attach the Cone Brackets.

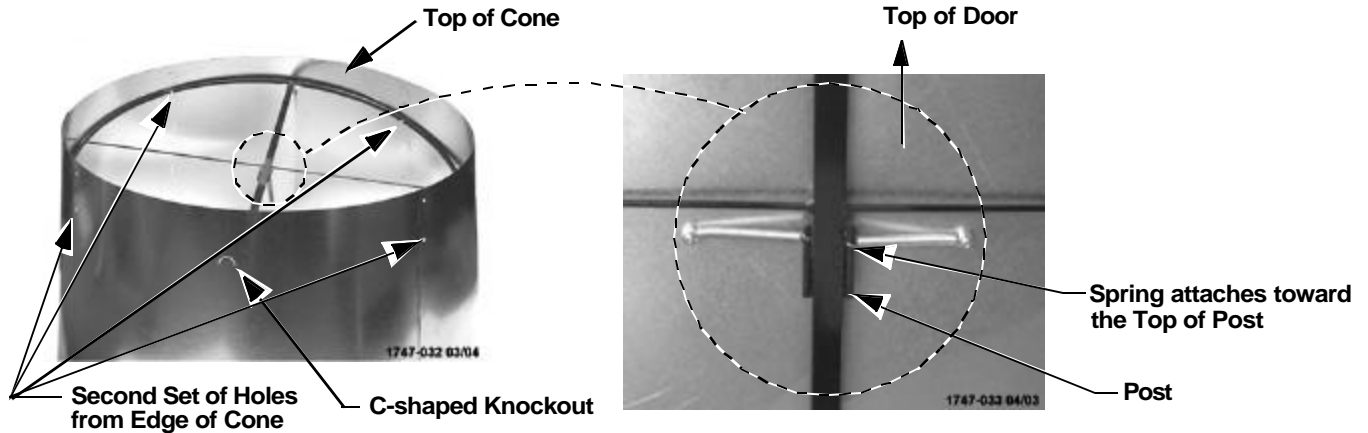
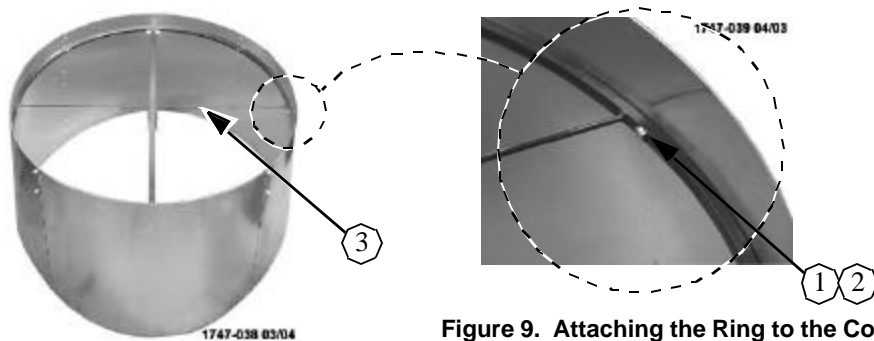

Figure 8. Installing the Door

Use (2) 5/16 x 1.25" Bolts and 5/16 Flange Nuts to attach the Ring to the Cone using the Holes located on both sides near the Door Center Brace as shown below. Note that the Nuts go on the outside of the Cone.



Item	Description
1	5/16 x 1/2" Carriage Bolt
2	5/16 Flange Nut
3	Door Center Brace

Figure 9. Attaching the Ring to the Cone

Turn the Cone over to install the Grill. Orient the Grill so the Leg with the bent spokes at the Center of the Grill is Parallel with the Center Door Hinge and that the bent Spokes are either above or below center. Not to the left or right. (See Figure 10). Install the Rubber Grommet 3/4" to 1" from the end of the bent Spokes. Fasten the Grill on with (8) 5/16 x 1/2" Carriage Bolts and Flange Nuts as shown below. Note that the Nuts are to the Inside of the Cone.

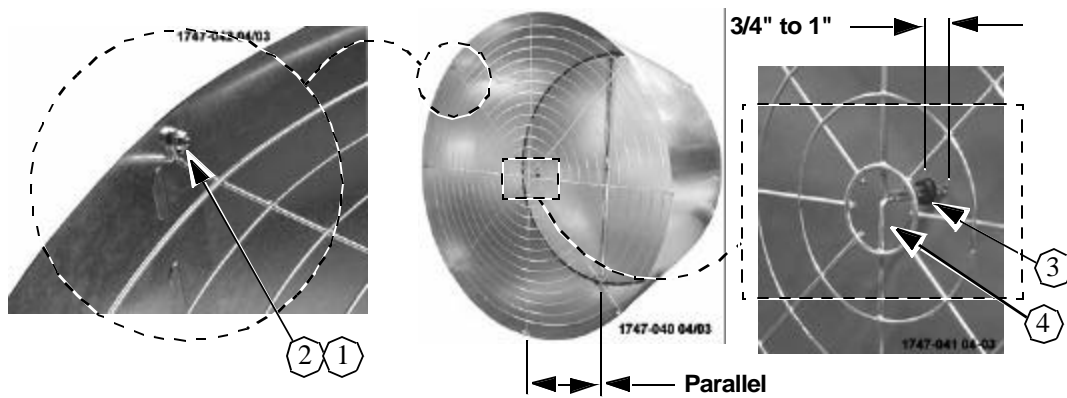

Item	Description
1	5/16 x 1/2" Carriage Bolt
2	5/16 Flange Nut
3	Rubber Grommet
4	Leg with Bent Spokes

Figure 10. Attaching the Grill

Assembling the Cone to the Fan

Use 5/16 x 1/2" Carriage Bolts and 5/16 Flange Nuts to attach the Cone Brackets to the Fan Shroud as shown. The Shorter Cone Brackets go on the top. The Longer Cone Brackets go on the bottom as shown in **Figure 11**.

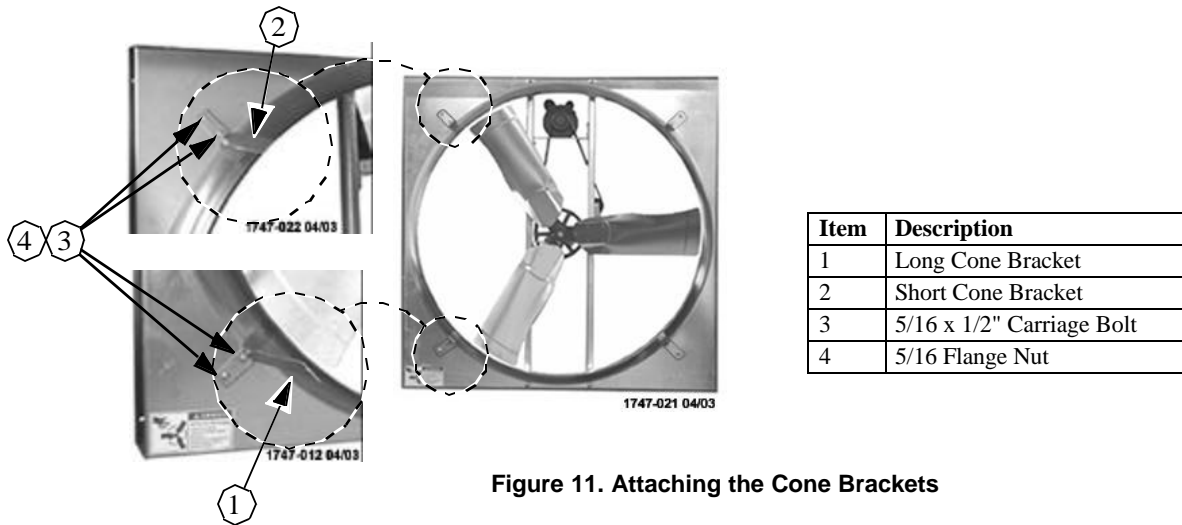

Figure 11. Attaching the Cone Brackets

Mounting the Cone and Door Assembly on the Fan requires at least two people. Pick up the Cone and rest the Cone on top of the Fan Orifice as shown in **Figure 12A**. Attach the top of the Cone to the Cone Brackets with the Bolts that were previously threaded through the Ring and Cone and 5/16 Flange Nuts (**Figure 12A**). Only hand tighten the Nuts at this time. Working around the Fan Orifice in a circular motion Slide the Cone over the Fan Orifice. The Cone will Fit snug over the Fan Orifice. Use the Bolts previously threaded through the Ring and Cone and the 5/16 Flange Nuts to secure the bottom of the Cone to the Fan (**Figure 12B**). Use a Level and rotate the Cone until the Door center rail is Vertical. Now tighten all Hardware (See **Figure 12C**).

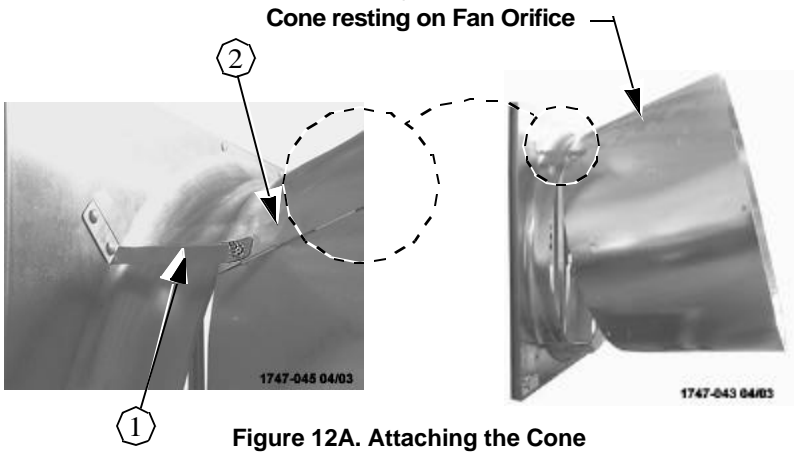

Figure 12A. Attaching the Cone

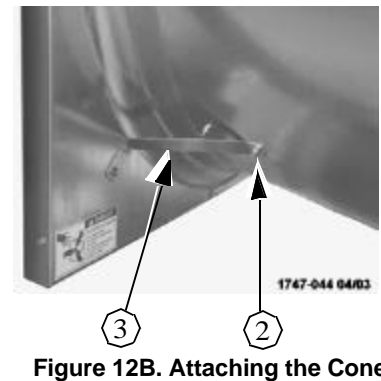
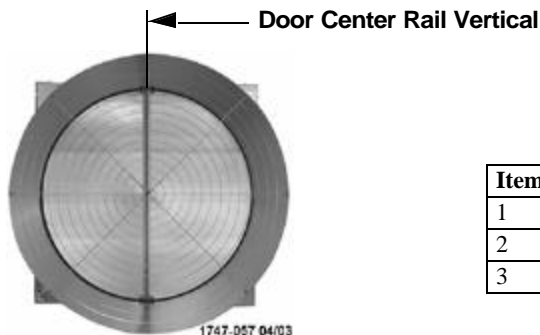

Figure 12B. Attaching the Cone



Item	Description
1	Short Cone Bracket
2	5/16 Flange Nut
3	Long Cone Bracket

Figure 12C. Attaching the Cone

Wiring

1. Check that the electrical power being supplied to the Fan matches the electrical Specifications on the Fan Decal.
2. Remove the Motor Access Cover.
3. Install an electrical disconnect within reach of each Fan installed.
4. Connect the cord to the motor according to the wiring diagram on the motor. Verify that the motor is connected for counter clockwise rotation (viewing the back of the motor, opposite the shaft end.)

Follow local, state, and national electrical codes for wiring.

Installing the Screen

Cut out one section of the Screen to route the cord out of the Fan: This will allow for the Screen to be removed without interfering with the Cord. (See Figure 13). Attach the cord to the Wall using a Lag Screw and Cord Clip. Allow enough slack in the cord to form a "drip loop" for moisture to fall away from the cord and not into the motor.

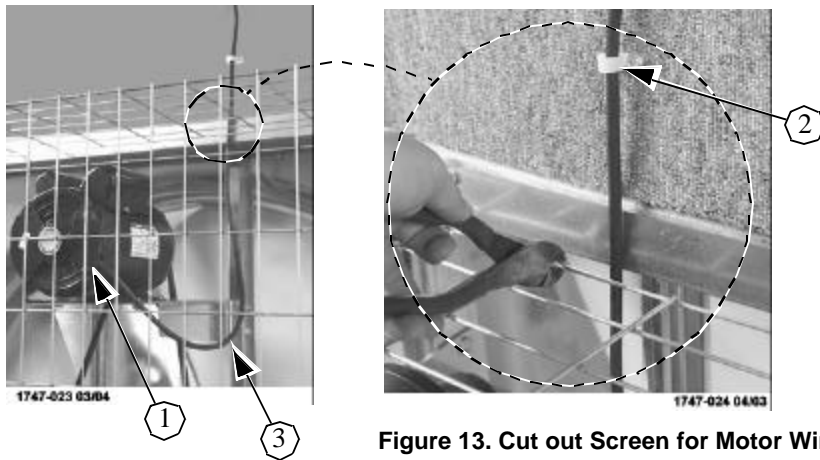

Item	Description
1	Motor Access Cover
2	Cord Clip
3	Drip Loop

Figure 13. Cut out Screen for Motor Wiring

Hang the Rear Screen on the four tabs located in the corners of the Fan Mounting Flange. Position the Screen so that the Screen wire is captured between the 1/8" tall tabs and the Screen Clips. Rotate the two Screen Clips to capture the Screen (See Figure 14).

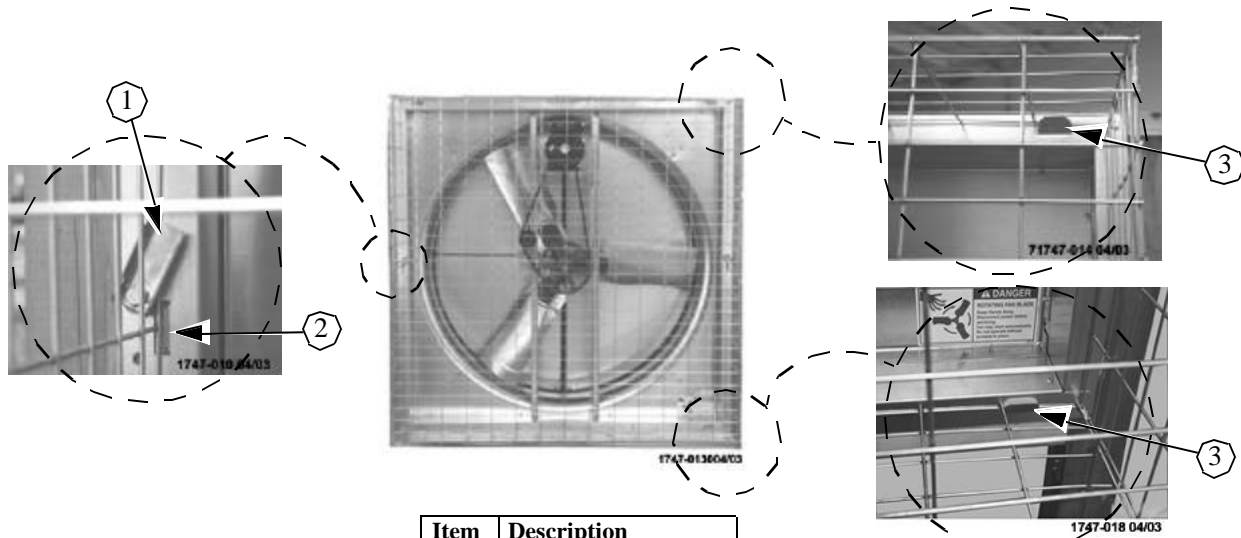

Item	Description
1	Screen Clip
2	1/8" tall Tab
3	Screen Mounting Tabs

Figure 14. Installing the Screen

Maintenance

IMPORTANT! Disconnect Power Prior To Maintaining Or Cleaning The Fan. The fan may start automatically causing serious injury or death.

- Service and repair of fans should be done only by a qualified technician.
- Keep the fan clean for maximum life and best performance. **Do Not spray water on Fan Shaft Bearings or Motor.**
- Periodically check the V-Belt and replace if necessary. A worn Belt will cause a substantial drop in Fan performance or it can break and cause Fan failure. If a Belt rides below the Sheave edge, replace the belt. (See **Figure 15** below)

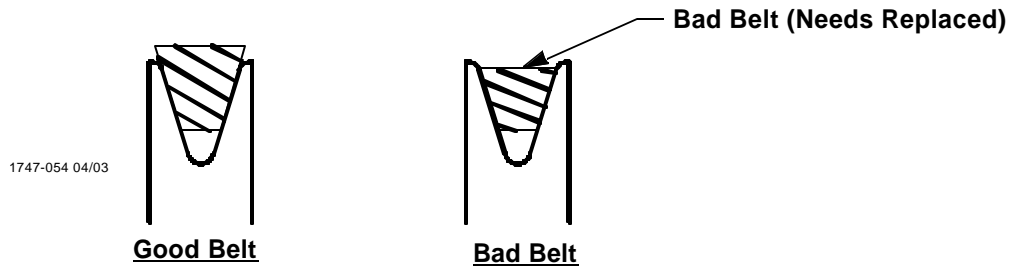

Figure 15. Belt Condition

- Check Belt Tension. The Belt should be tensioned just tight enough to minimize Belt slippage. Over tensioning the belt will cause premature Belt and Bearing wear. With a new Belt the Idler Sheave indicator mark should line up with the third notch in the Tensioner Housing (See **Figure 16**).

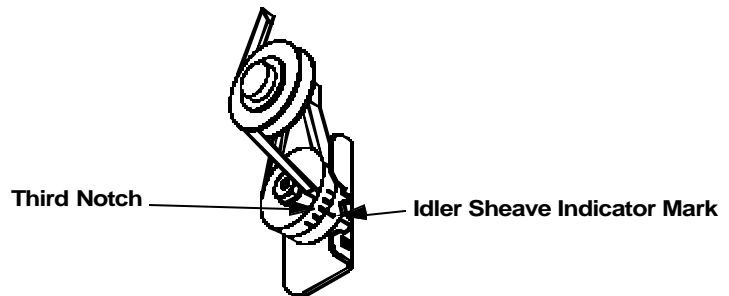

Figure 16. Idler Sheave Indicator Mark

- Keep Shutters, Blades, and Housing clear of obstacles for best air performance.
- The motor and Fan Shaft Bearings are pre-lubricated. Grease zerks are provided on the fan shaft bearings for installations where re-lubrication is needed. Add only a small amount of grease to purge impurities out of the bearing seals. Use only high quality lithium soap base grease and clean all dirt from zerk before applying grease. Chore-Time recommends using Shell Alvania # 2 in the fan shaft bearings.
- Check Sheaves for wear. Replace if a Sheave groove is worn. (See **Figure 17**)

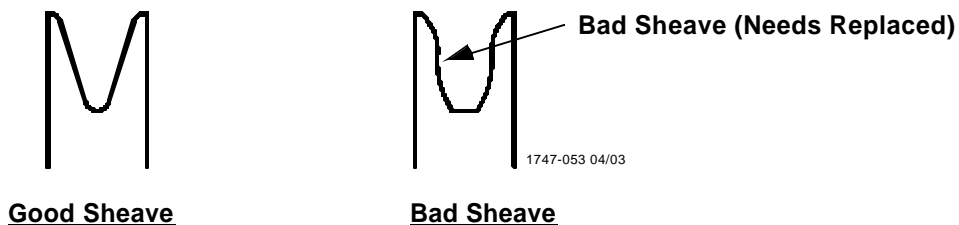
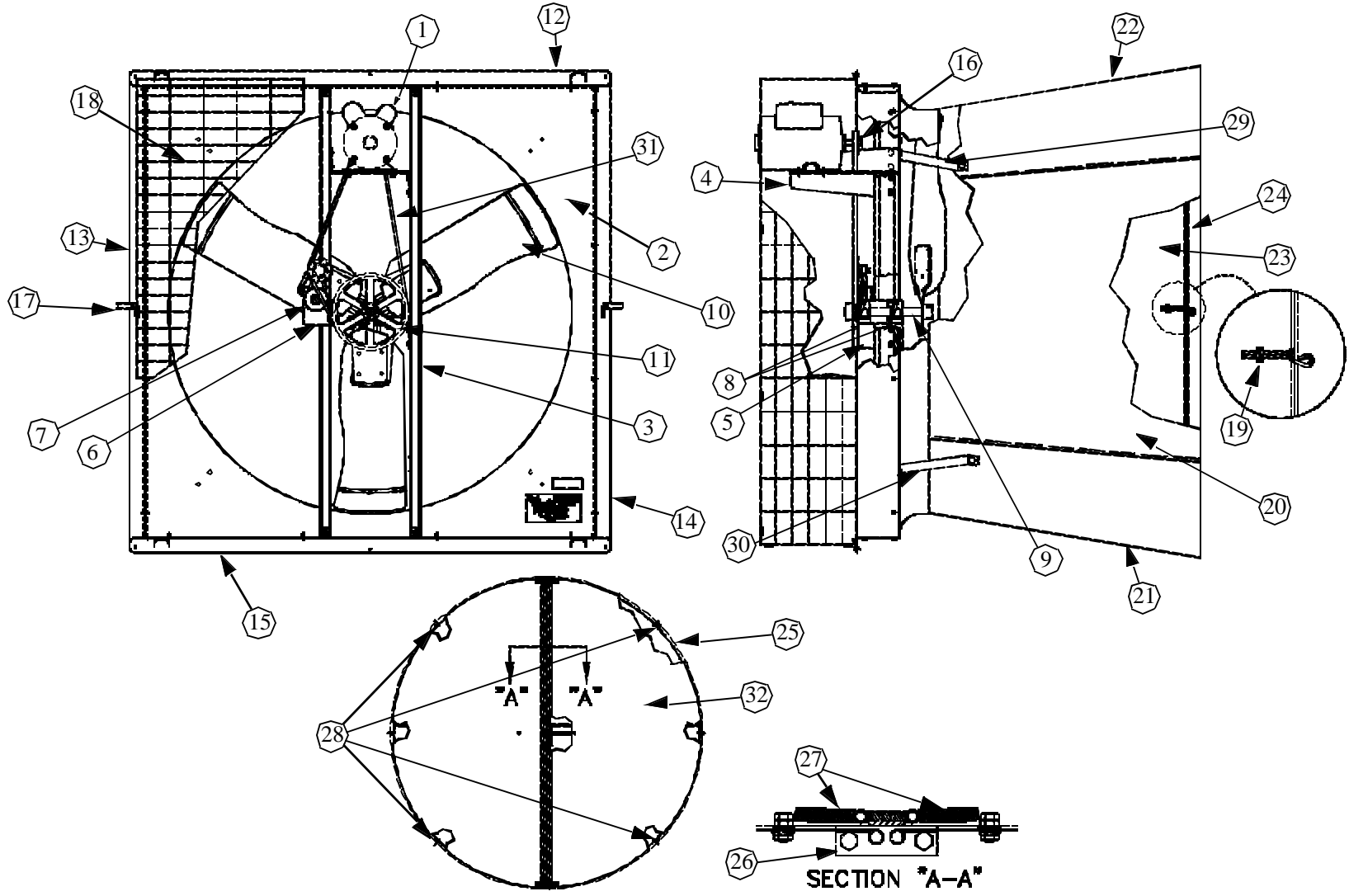

Figure 17. Sheave Condition

48" Hyflo™ Itemized Parts



48" and 52" Hyflo™ Part Numbers

48193	2	32	Door, 48" Hyflo Shutter
See Table 2	1	31	Belt
48312	2	30	Bracket, Cone Bottom Support
48313	2	29	Bracket, Cone Top Support
48427	4	28	Magnet, .125 THK. X .50 DIA.
48440	2	27	Spring
48190	2	26	Plate, Fan Door Pivot Bottom
48185	1	25	Frame, 48" Fan Hyflo Door
47944	1	24	Grill, 59" OD Galv Cone
48657	1	23	Panel, Cone L.H. 48" Hyflo
48658	1	22	Panel, Cone Top 48" Hyflo
48659	1	21	Panel, Cone Bottom 48" Hyflo
48311	1	20	Panel, Cone R.H. 48" Hyflo
48426	1	19	Grommet, .31 ID. X .75 OD.
48794	1	18	Screen Assembly
36729	2	17	Screen Clip
See Table 2	1	16	Sheave
48673	1	15	Panel, 48" Hyflo Bottom
48672-2	1	14	Panel, 48" Hyflo Side 5" (R.H.)
48672-1	1	13	Panel, 48" Hyflo Side 5" (L.H.)
48671	1	12	Panel, 48" Hyflo Top
See Table 2	1	11	Sheave
See Table 2	1	10	Blade, 48" Fan
48397	1	9	Shaft, Idler Drive Fan
48428	2	8	Bearing, 1" Cast Pillow Block
48429	1	7	Tensioner, Assembly 3.5" Arm 3" Dia.
48394	1	6	Tensioner Support
48395	1	5	Bearing Support Idler Drive
48396	1	4	Motor Support Idler Drive
48393	2	3	Post, 48" Fan
48362	1	2	Shroud, 48" Fan
See Table 2	1	1	Motor
PART NO.	QTY	ITEM	DESCRIPTION

Table 1. 48320-XX 48" Hyflo Fan Models

48453	2	32	Door, 52" Hyflo Shutter
See Table 4	1	31	Belt
48469	2	30	Bracket, Cone Bottom Support
48470	2	29	Bracket, Cone Top Support
48427	4	28	Magnet, .125 THK. x .50 Dia.
48440	2	27	Spring
48190	2	26	Plate, Fan Door Pivot Bottom
48434	1	25	Frame, 52" Fan Hyflo Door
48475	1	24	Grill, 64" OD Galv Cone
48681	1	23	Panel, Cone L.H. 52" Hyflo
48682	1	22	Panel, Cone Top 52" Hyflo
48683	1	21	Panel, Cone Bottom 52" Hyflo
48447	1	20	Panel, Cone R.H. 52" Hyflo
48426	1	19	Grommet, .31 ID. X .75 OD.
48794	1	18	Screen Assembly
36729	2	17	Screen Clip
See Table 4	1	16	Sheave
48686	1	15	Panel, 52" Hyflo Bottom
48684-2	1	14	Panel, 52" Hyflo Side 5" (R.H.)
48684-1	1	13	Panel, 52" Hyflo Side 5" (L.H.)
48685	1	12	Panel, 52" Hyflo Top
See Table 4	1	11	Sheave
See Table 4	1	10	Blade, 52"
48397	1	9	Shaft, Idler Drive Fan
48428	2	8	Bearing, 1" Cast Pillow Block
48429	1	7	Tensioner, Assembly 3.5" Arm 3" Dia.
48394	1	6	Tensioner Support, Idler Drive
48395	1	5	Bearing Support, Idler Drive
48396	1	4	Motor Support, Idler Drive
48072	2	3	Post, 52" Fan
47710	1	2	Shroud, 52" Fan
See Table 4	1	1	Motor
PART NO.	QTY	ITEM	DESCRIPTION

Table 3. 48483-XX 52" Hyflo Fan Models

-23,-51,-52	48505	1	31	Belt (A59)
-21,-22,-41,-42	48430	1	31	Belt (A60)
-23	1381	1	16	Sheave, AK27.625 X 2.7 OD
-51,-52	48504	1	16	Sheave, AK32.625 X 3.25 OD
-21,-22,-41,-42	8773	1	16	Sheave, AK30.625 X 3.05 OD
-23,-51,-52	28143	1	11	Sheave, AK84
-21,-22,-41,-42	40274	1	11	Sheave, AK94
-22-42-52	28140	1	10	Blade, 48" Fan 1" Bore (STD)
-23	45932	1	10	Blade, 48" Fan 1" Bore (High Efficiency)
-21,-41,-51	46748	1	10	Blade, 48" Fan 1" Bore (High Capacity)
-21	47691	1	1	Motor, 1.5 HP
-41,-51,-52	47693	1	1	Motor, 1.5 HP
-22,-23	37729	1	1	Motor, 1 HP
-42	40157	1	1	Motor, 1 HP
48320-XX	PART NO	QTY	ITEM	DESCRIPTION

Table 2. 48" Model Component Variations

-22,-42	48430	1	31	Belt (A60)
-21,-41	48541	1	31	Belt (AX60)
-52	48505	1	31	Belt (A59)
-51	48615	1	31	Belt (AX59)
-51,-52	48504	--	16	Sheave, AK32
-21,-22,-41,-42	8773	1	16	Sheave, AK30
-51,-52	28143	1	11	Sheave, AK84
-21,-22,-41,-42	40274	1	11	Sheave, AK94
-22-42-52	48507	1	10	Blade, 52" Fan 1" Bore (STD)
-21,-41,-51	48125	1	10	Blade, 52" Fan 1" Bore (Hi Cap)
-42,-52	47693	1	1	Motor, 1.5 HP
-41,-51	48608	1	1	Motor, 1.5 HP
-22	47691	1	1	Motor, 1.5 HP
-21	48580	1	1	Motor, 1.5 HP
48483-XX	Part No.	QTY	ITEM	DESCRIPTION

Table 4. 52" Model Component Variations

Safety Information

Carefully read all safety messages in this manual and on your equipment safety signs. Follow recommended precautions and safe operating practices. Keep safety signs in good condition. Replace missing or damaged safety signs.

DANGER: Electrical Hazard

Disconnect electrical power before inspecting or servicing equipment. Ground all electrical equipment for safety. All electrical wiring must be done by a qualified electrician in accordance with local and national electric codes. Ground all non-current carrying metal parts to guard against electrical shock. With the exception of motor overload protection, electrical disconnects and over current protection are not supplied with the equipment.

DANGER: Rotating Fan Blade

Keep Hands away. Disconnect power before servicing. Fan may start automatically. Do not operate the Fan without the screens in place. Disregard to these things will cause serious injury including death.



Warranty

Chore-Time Equipment (“Chore-Time”) warrants each new Chore-Time product manufactured by it to be free from defects in material or workmanship for one year from and after the date of initial installation by or for the original purchaser. If such a defect is found by the Manufacturer to exist within the one-year period, the Manufacturer will, at its option, (a) repair or replace such product free of charge, F.O.B. the factory of manufacture, or (b) refund to the original purchaser the original purchase price, in lieu of such repair or replacement. Labor costs associated with the replacement or repair of the product are not covered by the Manufacturer.

Conditions and Limitations

1. The product must be installed by and operated in accordance with the instructions published by the **Manufacturer** or **Warranty will be void.**
2. Warranty is void if **all components** of the system are not original equipment supplied by the **Manufacturer.**
3. This product must be purchased from and installed by an authorized distributor or certified representative thereof or the Warranty will be void.
4. Malfunctions or failure resulting from misuse, abuse, negligence, alteration, accident, or lack of proper maintenance shall not be considered defects under the Warranty.
5. This Warranty applies only to systems for the care of poultry and livestock. Other applications in industry or commerce are not covered by this Warranty.

The **Manufacturer** shall not be liable for any **Consequential or Special Damage** which any purchaser may suffer or claim to suffer as a result of any defect in the product. **“Consequential”** or **“Special Damages”** as used herein include, but are not limited to, lost or damaged products or goods, costs of transportation, lost sales, lost orders, lost income, increased overhead, labor and incidental costs and operational inefficiencies.

THIS WARRANTY CONSTITUTES THE MANUFACTURER’S ENTIRE AND SOLE WARRANTY AND THIS MANUFACTURER EXPRESSLY DISCLAIMS ANY AND ALL OTHER WARRANTIES, INCLUDING, BUT NOT LIMITED TO, EXPRESS AND IMPLIED WARRANTIES AS TO MERCHANTABILITY, FITNESS FOR PARTICULAR PURPOSES SOLD AND DESCRIPTION OR QUALITY OF THE PRODUCT FURNISHED HEREUNDER.

Chore-Time Distributors are not authorized to modify or extend the terms and conditions of this Warranty in any manner or to offer or grant any other warranties for Chore-Time products in addition to those terms expressly stated above. An officer of CTB, Inc. must authorize any exceptions to this Warranty in writing. The Manufacturer reserves the right to change models and specifications at any time without notice or obligation to improve previous models.

Contact your nearby Chore-Time distributor or representative for additional parts and information.

CTB Inc.

P.O. Box 2000 • Milford, Indiana 46542-2000 • U.S.A.

Phone (574) 658-4101 • Fax (877) 730-8825

E-Mail: ctb@ctbinc.com • Internet: <http://www.ctbinc.com>

Printed in the U.S.A.