



CHORE-TIME®

A Division of CTB, Inc.
Made to Work. Built to Last. ☺
P.O. Box 2000 State Road 15 North
Milford, IN. 46542-2000 U.S.A.
574-658-4101 Fax 877-730-8825
www.choretimepoultry.com



Owner/Operator Manual

FOR YOUR SAFETY

If you smell gas:

1. Open Windows
2. Don't touch electrical switches
3. Extinguish any open flame
4. Immediately call your gas supplier

FOR YOUR SAFETY

Do not store or use gasoline or other flammable vapors and liquids in the vicinity of this or any other appliance.

POUR VOTRE SURETE

Si vous sentez une odeur de gaz:

1. Ouvrez les fenêtres
2. Ne touchez pas aux de commutateurs électriques
3. Eteindre n'importe quelle ouverture flambe
4. Immédiatement appeler votre fournisseur de gaz

POUR VOTRE SURETE

Pas l'essence de magasin ou usage ou les autres vapeurs et les liquides inflammables à proximité de cet ou l'autre appareil.

Note: The original, authoritative version of this manual is the English version produced by CTB, Inc. or any of its subsidiaries or divisions, (hereafter collectively referred to as "CTB"). Subsequent changes to any manual made by any third party have not been reviewed nor authenticated by CTB. Such changes may include, but are not limited to, translation into languages other than English, and additions to or deletions from the original content. CTB disclaims responsibility for any and all damages, injuries, warranty claims and/or any other claims of any nature associated with such changes, inasmuch as such changes result in content that is different from the authoritative CTB-published English version of the manual. For current product installation and operation information, please contact the customer service and/or technical service departments of the appropriate CTB subsidiary or division. Should you observe any questionable content in any manual, please notify CTB immediately in writing directed to: CTB Legal Department, P.O. Box 2000, Milford, IN 46542-2000 USA.















WARNING !



SERIOUS PERSONAL INJURY AND/OR DEATH MAY RESULT FROM USE OF THIS HEATER IN AN UNVENTILATED BUILDING OR IN HUMAN LIVING AREAS.

LE RESULTAT DE MAI DE MORT DE ET/OU DE BLESSURE PERSONNEL SERIEUX DE L'USAGE DE CET APPAREIL DE CHAUFFAGE DANS UN CONSTRUISANT UNVENTILATED OU DANS L'HUMAN SECTEURS VIVANTS

EL USO DE ESTA CALENTADORA EN UN EDIFICIO SIN VENTILACIÓN O EN UNA AREA HUMANA PUEDE RESULTAR EN ENFERMEDAD Y/O MUERTE

- | | |
|---|---|
| <p> Do not use the heater to heat human living areas. The intended use of the heater is to provide warmth for poultry and hog buildings. Adequate ventilation must be provided.</p> | <p> Ne pas utiliser l'appareil de chauffage pour chauffer humain habiter les secteurs. L'usage voulu de l'appareil de chauffage sera obligé à fournir la chaleur pour les bâtiments de volaille et cochon. La ventilation suffisante doit être fournie.</p> |
| <p> Use only the type of gas being supplied to the unit as marked on it (Propane or Natural Gas). Do not operate with improper fuel. Ventilation air and combustion air must not be obstructed.</p> | <p> Utiliser seulement le type de gaz étant fourni à l'unité comme marqué dessus (le Propane ou le Gaz Naturel). Ne pas fonctionner avec le carburant déplacé. L'air de ventilation et l'air de combustion ne doivent pas être encombrés.</p> |
| <p> Test all pipe and pipe joints for leaks by a suitable means (Example: soap and water solution or a pressure check). Do not use open flame to test for gas leaks. Do not operate the heater until this test has been performed.</p> | <p> Essayer tous joints de tuyau et tuyau pour les fuites par un moyens convenables Pas l'usage ouvre la flamme pour essayer pour les fuites de gaz. (l'Exemple : la solution de savon et eau ou un contrôle de pression). Ne pas fonctionner l'appareil de chauffage jusqu'à ce que ce test a été préformé.</p> |
| <p> Do not move, handle, repair, or adjust height of the heater while in operation or when still hot. Do not bypass any safety devices.</p> | <p> Pas le mouvement, la poignée, la réparation, ou ajuster la hauteur de l'appareil de chauffage pendant que dans l'opération ou quand calme chaud. Ne pas sauter d'appareils de sûreté.</p> |
| <p> Before each use, a visual inspection of the heater is essential to insure safe and satisfactory heating. Replace or repair defective components before operating heater. Failure to do so will void warranty and could result in injury or property damage.</p> | <p> Avant que chaque usage, une inspection visuelle de l'appareil de chauffage est essentielle pour assurer le chauffage sûr et satisfaisant. Remplacer ou réparer des composants le défectueux avant de fonctionner appareil de chauffage. L'échec pour ainsi faire annulera la garantie et pourrait avoir pour résultat les dommages de blessure ou propriété.</p> |
| <p> The installation of these appliances is to be in accordance with CAN/CGA-B149., B149.2 and National Fuel Gas Code, ANSI 2223.1/NFPA 54 installation codes for gas burning appliances and equipment and/or local codes.</p> | <p> L'installation de ces appareils sera obligé à être conformément à CAN/CGA-B149.1, B149.2 et Code de Gaz de Carburant National, ANSI 2223.1/NFPA 54 codes d'installation pour le gaz appareils ardents et et/ou d'équipement codes locaux.</p> |
| <p> WARNING: Improper installation, adjustment, alteration, service or maintenance could cause property damage, injury or death. Read the installation, operating and maintenance instructions thoroughly before installing or servicing this equipment.</p> | <p> L'AVERTISSEMENT : l'installation Déplacée, l'ajustement, le changement, le service ou l'entretien peuvent causer les dommages de propriété, la blessure ou la mort. Lire l'installation, fonctionnant et les instructions d'entretien à fond avant d'installer ou entretenir cet équipement.</p> |

 **WARNING** Failure to follow the WARNINGS in this manual could result in serious personal injury or significant property damage.

THESE INSTRUCTIONS SHOULD BE LEFT WITH THE APPLIANCE AND THE USER TO RETAIN FOR FUTURE REFERENCE.

READ THESE INSTRUCTIONS THOROUGHLY BEFORE INSTALLING OR SERVICING THIS EQUIPMENT.

⚠ Before lighting, sniff all around the appliance area for a gas odor. Be sure to sniff next to the floor because propane gas is heavier than air and may temporarily exist at floor level.

Avant d'allumer, renifle tout autour le secteur d'appareil pour une odeur de gaz. Etre sûr de renifler à côté du plancher parce que le gaz de propane est plus lourd que l'air et peut exister temporairement au niveau de plancher.

Antes de encender, huela alrededor del área del artefacto para detectar si hay olor a gas. Asegúrese de oler cerca del piso, ya que el propano es más pesado que el aire y puede permnecer temporalmente a nivel del piso.

⚠ DO NOT ALLOW POWER CORDS AND/OR GAS SUPPLY HOSES TO REST ON THE CANOPY, HANGING BRACKETS OR OTHER HOT SURFACES OF THE UNIT OR TO COME WITHIN 12" OF THE HEATER.

Ne pas permettre tuyaux à la provision de gaz de et/ou de cordes de pouvoir pour se reposer sur le baldaquin, pendant des crochets ou les autres surfaces chaudes de l'unité Ou venir dans 12 » de l'appareil de chauffage.

NO PERMITA QUE CABLES DE ENERGÍA Y/O MANGUERAS DE SUMINISTRO DE GAS DESCANSEN SOBRE LA CAMPANA, LOS SOPORTES COLGANTES NI OTRAS SUPERFICIES CALIENTES DE LA UNIDAD NI QUE ESTÉN DENTRO DE UNA DISTANCIA DE 30,48 CM DEL CALENTADOR.

⚠ DSI UNITS MUST BE PROPERLY GROUNDED. DO NOT ALTER ELECTRICAL CORD.

LES UNITES DE DSI DOIVENT ETRE CONVENABLEMENT FONDE. Ne PAS CHANGER LA CORDE ELECTRIQUE.

LAS UNIDADES DSI DEBEN ESTAR CONECTADAS A TIERRA CORRECTAMENTE. NO MODIFIQUE EL CABLE ELÉCTRICO.

⚠ Plug in the three-prong power cord to a correctly grounded three-prong electrical outlet.

Brancher sur le cordon d'alimentation de trois-broche à un a fondé correctement la trois-broche sortie électrique.

Conecte el cable con enchufe de tres clavijas a una toma de corriente conectada a correctamente a tierra.

⚠ The installation of this appliance must in all cases conform with local and national building codes or in the absence of local codes with the current National Fuel Gas Code ANSI Z223.1/NFPA 54, or the Natural Gas and Propane Installation Codes, CSA B149.1 and B149.2.

L'installation de cet appareil doit dans tous cas conforme avec les codes de bâtiment locaux et nationaux ou en l'absence de codes locaux avec le Carburant le Gaz le Code ANSI Z223.1/NFPA National actuel 54, ou le Gaz Naturels et le Codes d'Installation de Propane, CSA B149.1, B149.2

La instalación de este artefacto debe hacerse, en todos los casos, de conformidad con los códigos de construcción locales y nacionales o, a falta de códigos locales, con el código estadounidense para gas combustible actualizado, ANSI Z223.1/NFPA 54, o con los códigos de instalación para gas natural y propano, CSA B149.1 y B149.2.

⚠ Heaters must be electrically grounded in accordance with the National Electrical Code, ANSINFP 70 or the current Canadian Electrical Code, CSA C22.1. Polarity of Line voltage and neutral wires must be maintained. The total load of all heaters in a circuit must be considered for overload control of that circuit.

Les appareils de chauffage doivent être électriquement fondé conformément au Code Electrique National, ANSINFP 70 ou le Code Electrique, canadien et actuel, CSA C22.1. La polarité de tension de Ligne et de fils neutres doit être maintenue. Le chargement total de tous appareils de chauffage dans un circuit doit être considéré pour le contrôle de surcharge de ce circuit.

Los calentadores se deben conectar a tierra de conformidad con el código eléctrico estadounidense, ANSINFP 70, o con el código eléctrico canadiense actualizado, CSA C22.1. Se debe mantener la polaridad del voltaje de línea y de los cables neutros. La carga total de todos los calentadores de un circuito se debe tomar en cuenta para el control de sobrecarga de ese circuito.

 **DANGER**
Check fitting for leaks. **Do Not Use** an open flame to check for leaks.

 **DANGER**
Do not attempt to clean the unit while it is operating or while it is still hot.

 **CAUTION**
Ventilation air and combustion air must not be obstructed.

CAUTION:
 Before each use, a visual inspection of the brooder/heater is essential to insure safe and satisfactory heating. Replace or repair defective components before operating brooder/heater. Failure to do so will void warranty and could result in injury or property damage.

 **CAUTION:**
Before attaching heater to gas supply line, purge gas supply line to free the supply of any contaminants.

 **CAUTION:**
Do not expose brooder to rain, snow, sleet, or water. The brooder/heater is designed for indoor use only.

 **CAUTION**
Use only the connections and/or fittings supplied with the unit.

 **CAUTION**
Use only the type of gas being supplied to the unit as marked on it (Propane or Natural Gas). Do not operate with improper fuel.

 **CAUTION**
This appliance is hot during normal operation. Avoid physical contact.

 **THE STATE OF CALIFORNIA REQUIRES THE FOLLOWING WARNING:**

 **WARNING**
Combustion by-products produced when using this product contain carbon monoxide, a chemical known to the State of California to cause cancer and birth defects (or other reproductive harm).

 **WARNING!**
During normal operation, the surfaces of the unit become very hot. It is VERY IMPORTANT that the power cords and gas supply hoses DO NOT TOUCH or REST ON ANY surface of the unit or to come within 12" of the heater.
During and after winching, make certain that ALL hoses and power supply cords are NOT resting on the heater nor are within 12" of the heater.
Failure to follow these instructions could result in serious personal injury or significant property damage.

 **WARNING!**
Failure to comply with all applicable local, state, and federal gas codes could result in serious personal injury and/or serious property damage.

DO NOT ALLOW ANYONE WHO HAS NOT READ THESE INSTRUCTIONS TO INSTALL, ASSEMBLE, LIGHT, ADJUST OR OPERATE THIS HEATER.
ONLY PERSONS WHO CAN UNDERSTAND AND FOLLOW THESE INSTRUCTIONS SHOULD USE OR SERVICE THIS HEATER.

**HIGH PRESSURE LARGE INFRARED BROODER
LP 40,000 BTU 120V 5PSI**

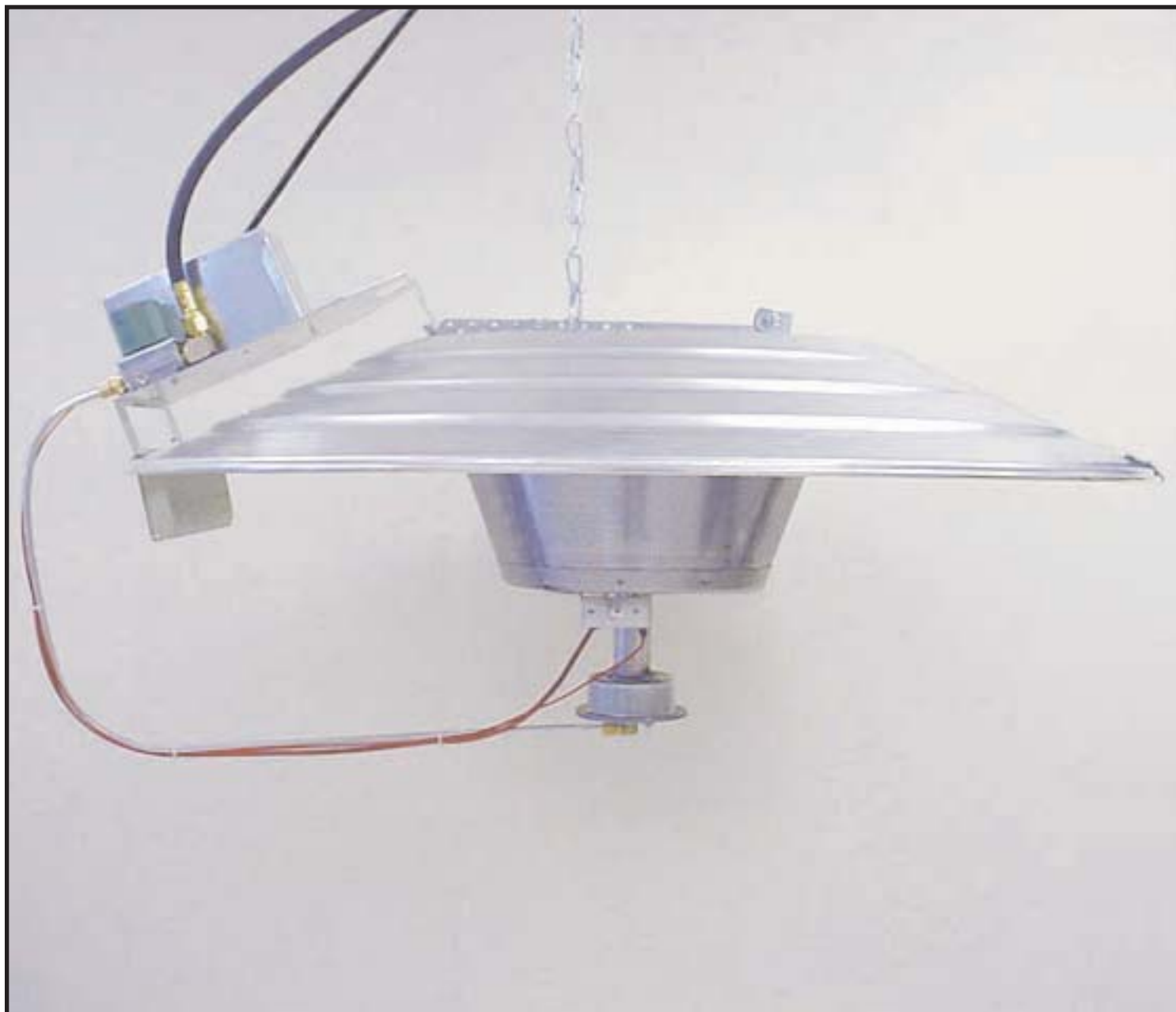

BROODER IS SHIPPED PRE-ASSEMBLED
TOOLS REQUIRED FOR INSTALLING BROODER:
3/4" wrench for tightening gas connections.

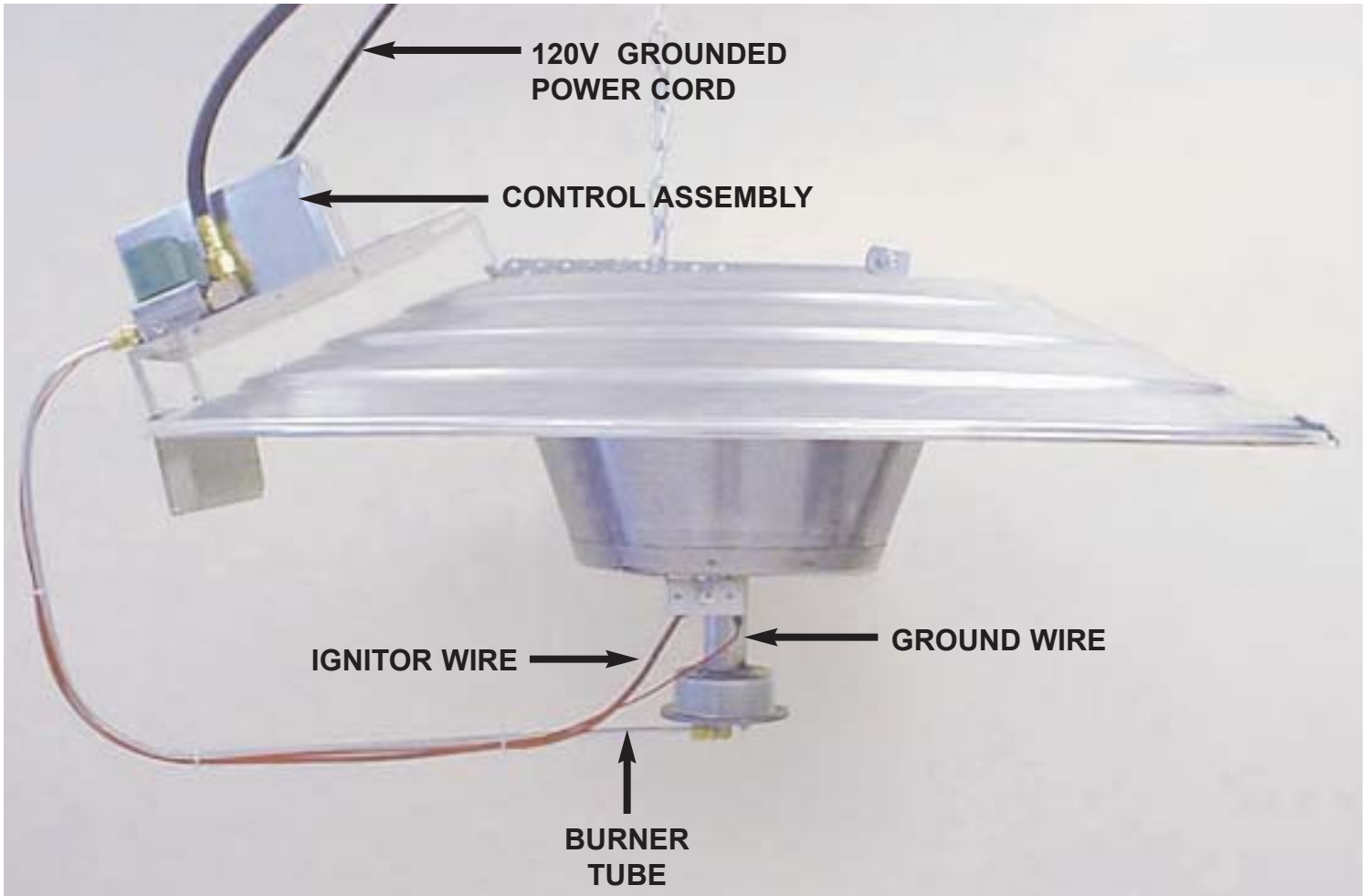

| | |
|--|-----------------------|
|  | 11004900 S-Hook Large |
|--|-----------------------|

| | |
|--|--------------------------|
|  | 21004002 Back "T" Hanger |
|--|--------------------------|

| | |
|--|---------------------------|
|  | 21014002 Front "T" Hanger |
|--|---------------------------|

| | |
|--|---------------------|
|  | 11000187 1/4-20 Nut |
|--|---------------------|

| | |
|--|----------------------------|
|  | 11000028 1/4-20 x 5/8 Bolt |
|--|----------------------------|

| | |
|--|-----------------------------------|
|  | 11000338 1/4-20 Washer Lock Split |
|--|-----------------------------------|

| | |
|--|-------------------------|
|  | 13005190 NUT 10-24 WING |
|--|-------------------------|

| | |
|--|------------------------------|
|  | 21002400 Shield Control Heat |
|--|------------------------------|

| | |
|---|-----------------------------|
|  | 18003945 Screw 10-24 X 3/8" |
|---|-----------------------------|

| | |
|---|-----------------------------|
|  | 18000021 Nut 10-24 Star Kep |
|---|-----------------------------|

| | |
|---|--------------------------|
|  | 11000118 COMP SLEEVE 1/4 |
|---|--------------------------|

| | |
|---|-----------------------|
|  | 11000191 COMP NUT 1/4 |
|---|-----------------------|

| | |
|---|-------------------------------------|
|  | 16-101443 Nut: Hex 10-24 18.8 SS |
|---|-------------------------------------|

| | |
|--|-------------------------------|
|  | 13005235 SCREW 8 X 1/2 TEK |
|--|-------------------------------|

| | |
|--|------------------------------|
|  | 13005213 WIRE TIES 5 1/2" |
|--|------------------------------|

| | |
|---|------------------------------|
|  | 16000104 1/4" Gas Hose Black |
|---|------------------------------|

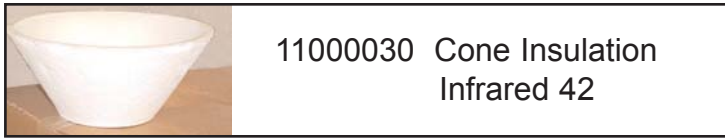

11000030 Cone Insulation
Infrared 42



16550065 Large Infrared
Emitter Asm.



16550072 BURNER ASM
HP LP LARGE



16500091
DISC: AIR PORT LP HP



16-1111 DISC: AIR PORT HYBRID



21000624 ELBOW BRASS
1/4MCT X 1/8MPT



16000053 ORIFICE #61



11010033 Canopy 34"
HD Aluminum
11011008 Canopy 34"
Galv.

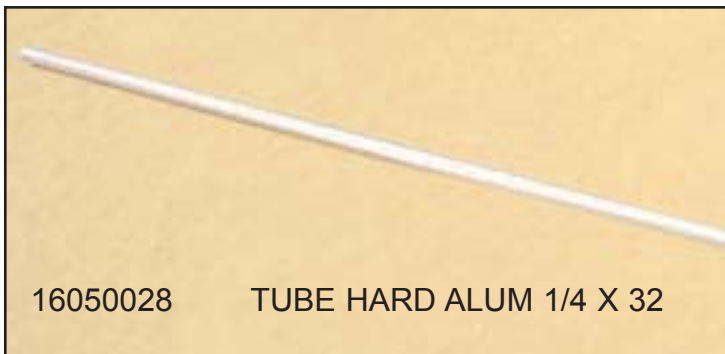

16050028 TUBE HARD ALUM 1/4 X 32

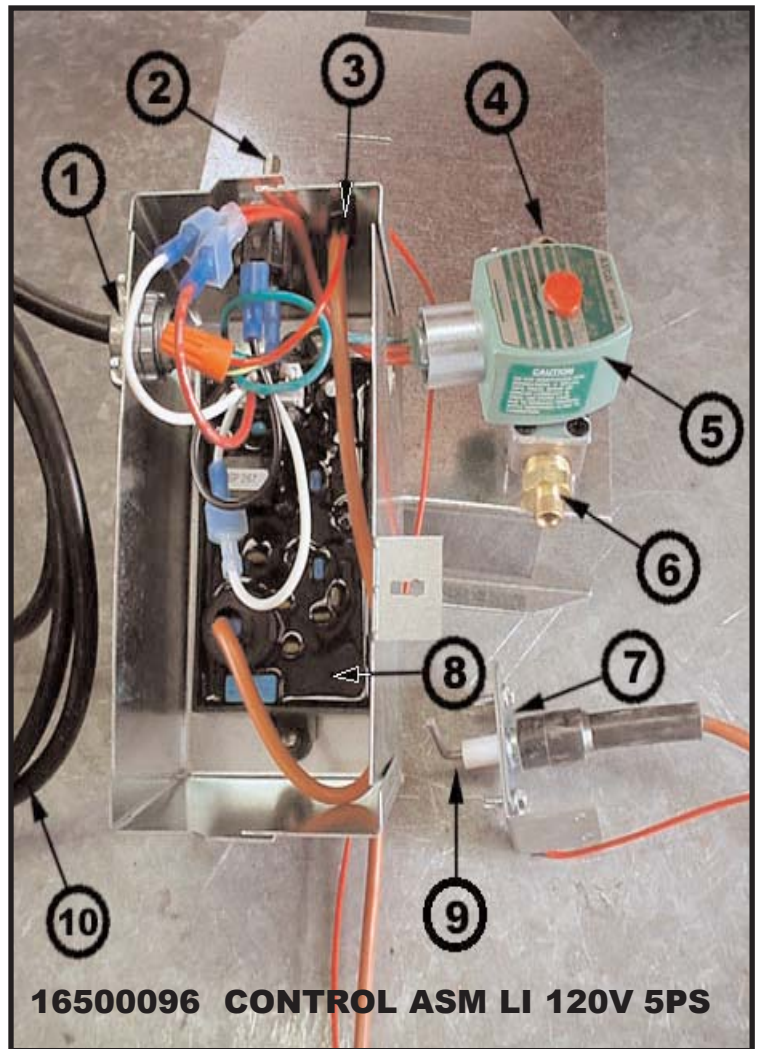

16500096 CONTROL ASM LI 120V 5PS

- | | | |
|----|-----------|------------------------|
| 1 | 13005072 | CONN BOX 3/8 STRAIN RE |
| 2 | 13005282 | SWITCH TOGGLE SINGLE P |
| 3 | 13008108 | WIRE STRAIN RELIEF |
| 4 | 16000054 | ELBOW BRASS 3/8MFT X 3 |
| 5 | 16000058 | VALVE ASCO 120V 5PSI |
| 6 | 18000037 | CONN 3/8MPT X 1/4MCT |
| 7 | 23004502 | IGN BRKT HYBRID LARGE |
| 8 | 16000059 | BOARD: CTRL DSI BRDR |
| 9 | 16-101197 | IGNITOR: DSI GB/SB SNG |
| 10 | 16-61225 | CORD: SJT W/PLUG-FG 1 |
| | 16000110 | WIRE HARNESS DSI 120V |

SUSPENDING THE HEATER

NOTE: To level the heater, simply support the heater underneath and then move the S-hooks forward or backward. We recommend that the valve side of the canopy be slightly lower (1 to 2 inches when in the operating position with hose and wiring connected) to insure that the gas valve assembly does not over heat. Keep gas hose away from hot surfaces. After it is level, clamp both ends of the s-hook shut. Normally the heater is attached to a winch cable used for raising and lowering.

In addition, we require that a safety cable or chain (not supplied with unit) be attached to the brooder to prevent the brooder from falling to the litter if the winching cable should happen to break.

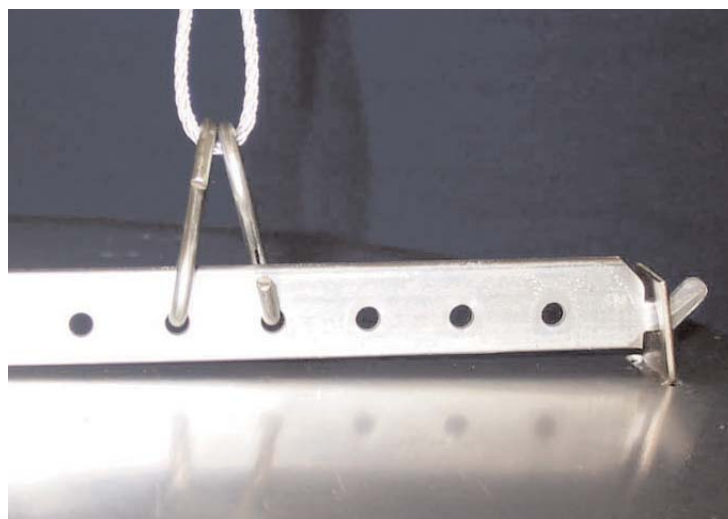

Installer MUST comply with all local, state, and federal gas codes for your area.

BROODER CLEARANCE

The heater must be located so there is a minimum clearance of 14" above the heater and 36" from the side. Any combustible material must not be adjacent to the heater.

The heater should be hung with a min. of 60" from the edge of the canopy to the floor.

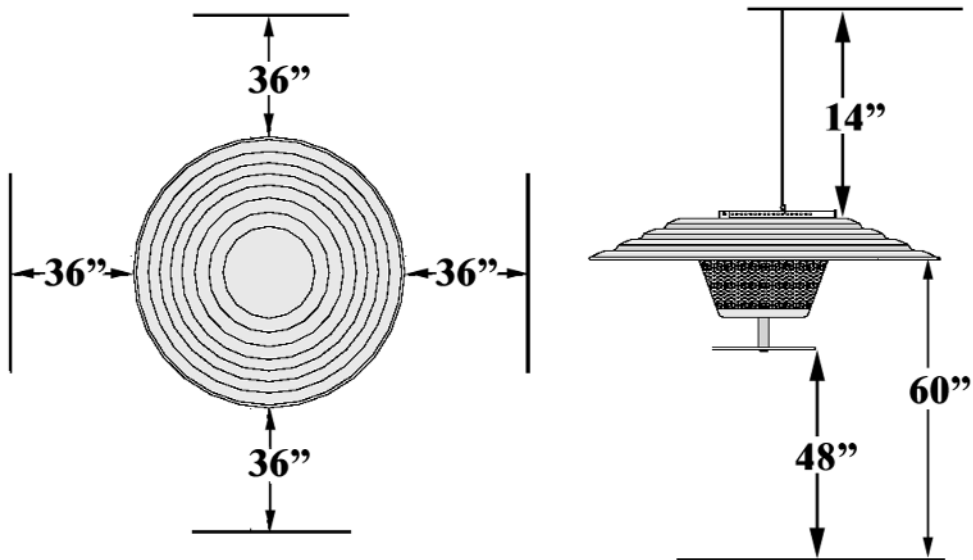

CONNECTING HEATER TO POWER SUPPLY

Insert grounded plug into 120 volt electrical outlet. Do not allow power cords and/or gas supply hoses to rest on the canopy, hanging brackets or other hot surfaces of the unit.

It is recommended that the regulator be sized to 130% of the load it is supplying. Gas layout and pipe sizing guidelines are available through your distributor.

 Failure to follow these instructions could result in serious personal injury or property loss.

CONNECT THE GAS HOSE TO THE CONTROL VALVE. Use Threaded Gas Connections Only. Heater Must Be Connected To Gas Supply Using The Hose And Connectors Provided With The Unit by the Manufacturer.

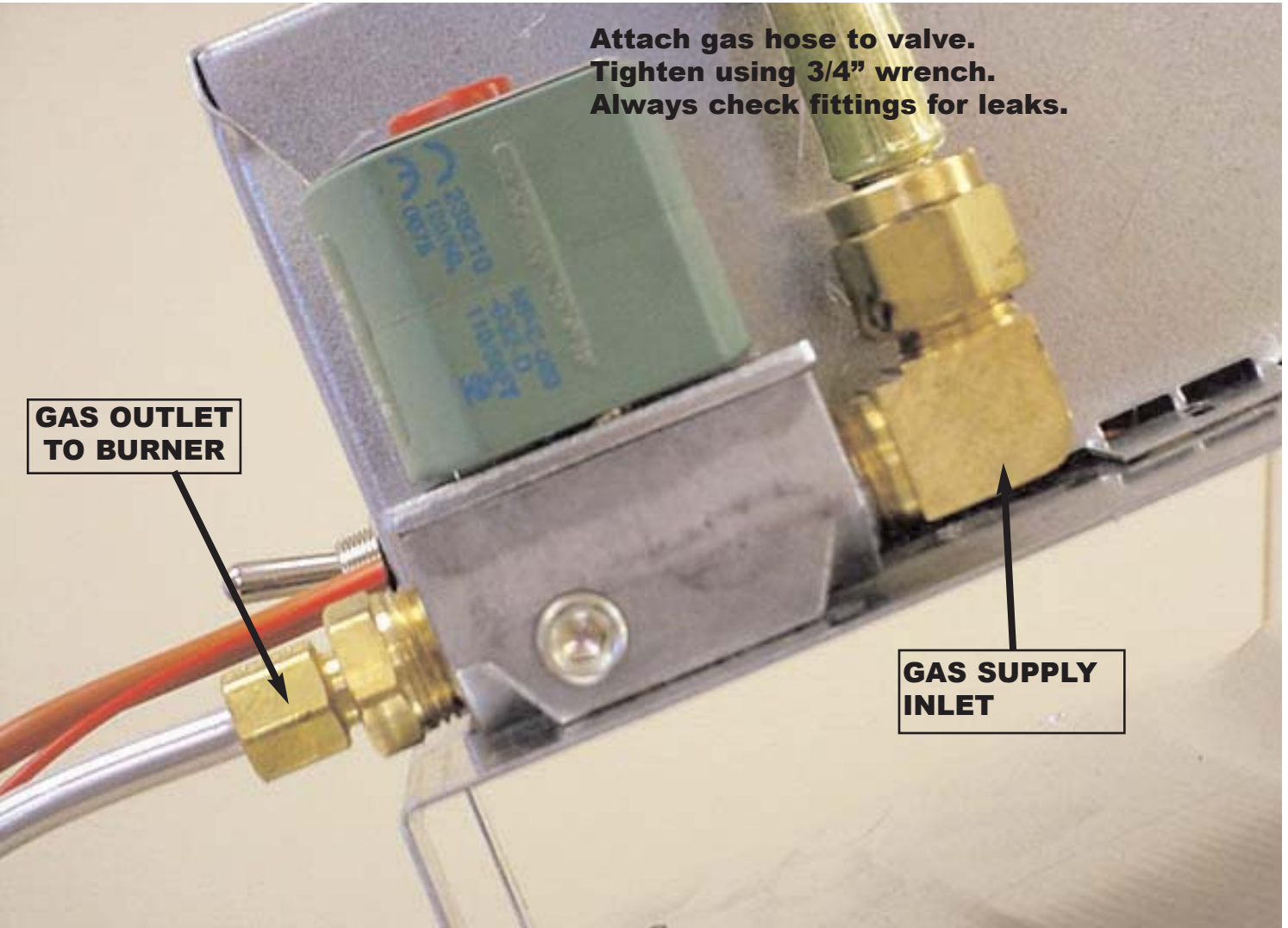

Turn on gas supply to the unit and **CHECK ALL FITTINGS AND CONNECTIONS FOR LEAKS** with a Gas Sensing Meter and /or soap solution.

Note: the burner connections can only be checked with the burner burning.

GAS PRESSURE - should be CHECKED AND ADJUSTED to recommended settings.

GAS Pressure:

FIRST - go to the furthest stove from the regulator and connect the pressure gauge to the Press Tap on the gas valve. Light only the stove you are testing or if you have a zone system light all the stoves in the zone. Set the pressure at a maximum of 5 P.S.I..

SECOND - light all stoves in the house and check the pressure again. The pressure should not drop below 4.5 P.S.I.. If the pressure does fall below 4.5 P.S.I., then the gas distribution system is inadequately designed. The problem may be a regulator, pipe sizing, etc.

120 VOLT WIRING DIAGRAM

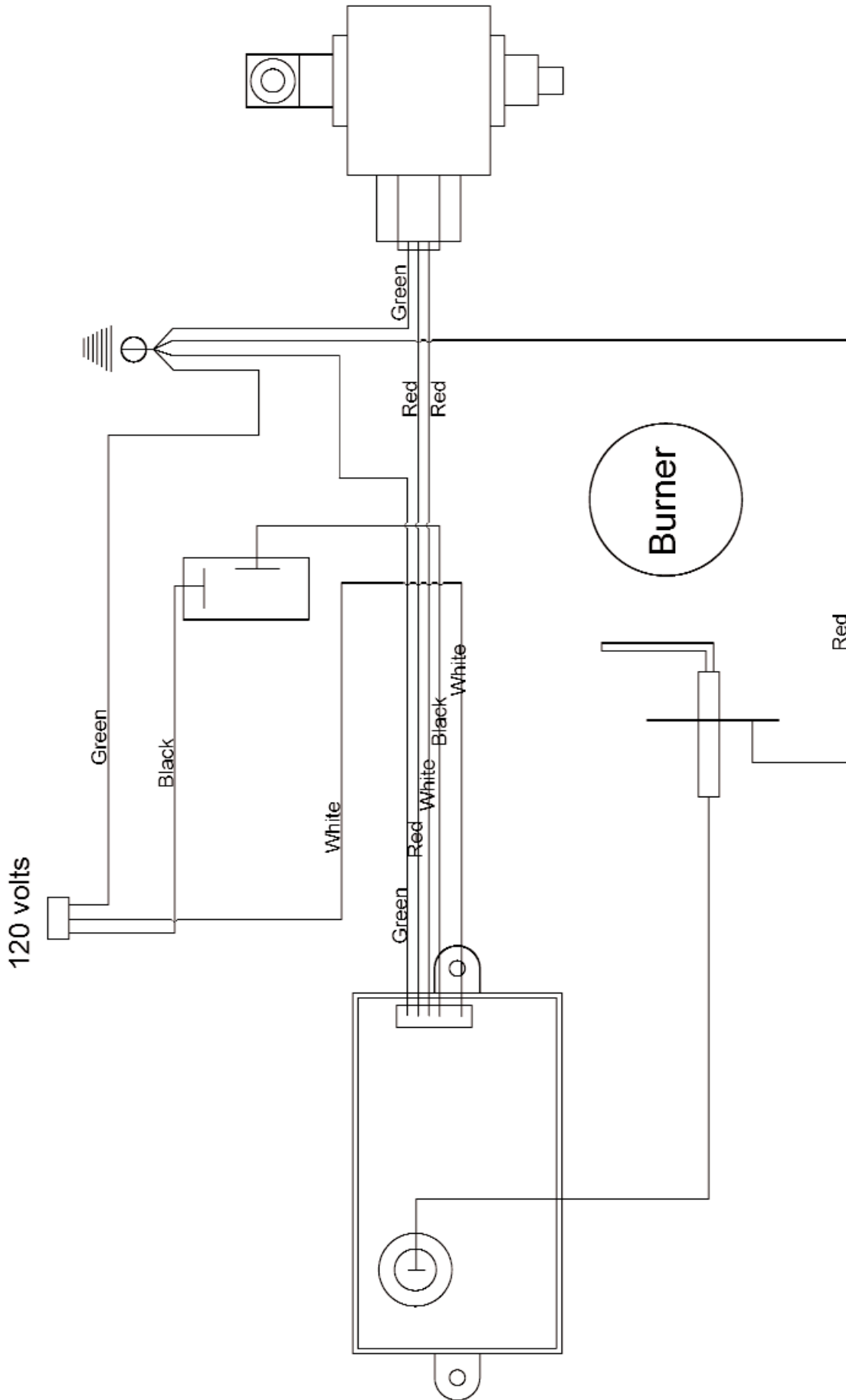

MAINTENANCE

Proper care and maintenance of your brooder cannot be over emphasized!!

A POORLY MAINTAINED HEATER WILL:

- Raise Operating Costs- due to poor combustion.
- Lower Air Quality
- Cause Inconsistent Temperatures
- Decrease the Life of the Heater



CAUTION



BEFORE PERFORMING ANY MAINTENANCE ON THE HEATER, MAKE CERTAIN THAT ALL POWER AND FUEL HAS BEEN SHUT OFF TO THE UNIT.



MAINTENANCE PROGRAM

- ◆ Daily: Check burner, it should be burning clear and blue; if not, clean as required or check gas pressure. Note: $\frac{3}{4}$ " yellow tip is a common characteristic of the flame on this brooder.
- ◆ Clean brooder/heater after each flock. Inspect for any orifice blockage caused by spider webs in the burner assemblies.
- ◆  **DANGER!** Never spray penetrating oil (WD-40) on the control valve. This will cause the loss of high temperature valve grease and cause the valve to leak.
- ◆ Clean dust and dirt from burner ports with compressed air. If an air compressor is not available turn the brooder/heater to a vertical position and tap on the side of the burner with a screwdriver, pliers, or any other suitable object, to knock the dust from the unit.
- ◆ If houses are washed down, care should be taken to prevent moisture from accumulating on control valve and burner assemblies. Cover valve and burner assemblies with plastic before washing. During wash down, do not get fiber radiant wet. After wash downs remove plastic from brooder/heater. We recommend that you light the brooders/heaters to dry up any excess moisture.
- ◆ For proper combustion it is important that the small holes in the Emitter be clean and unobstructed. The Emitter can be cleaned by inserting a long brass bristle brush between the outer and inner cones.
- ◆ Clean air intakes with a small brush.
- ◆ Extreme care must be taken not to enlarge or distort the burner orifices.
- ◆ If brooder/heater is disconnected from the gas line, use tape to seal the open connections. This will keep moisture, dust, and insects out and prevent future problems.
- ◆ Dust that accumulates on the canopy should be cleaned off before igniting brooder. If dust is left to burn off of galvanized canopies it will result in loss of galvanizing material and corrosion of the canopy.
- ◆  Failure to follow these instructions could result in serious personal injury or significant property damage.

WARRANTY

Manufacturer warrants each new product manufactured by it to be free from defects in material or workmanship for one (1) year from and after the date of initial installation by or for the original purchaser. If such a defect is found by Manufacturer to exist within the one-year period, the Manufacturer will, at its option, (a) repair or replace such product free of charge, F.O.B. the factory of manufacture, or (b) refund to the original purchaser the original purchase price, in lieu of such repair or replacement. Labor costs associated with the replacement or repair of the product are not covered by the Manufacturer.

Conditions and Limitations

1. The product must be installed by and operated in accordance with the instructions published by the **Manufacturer or Warranty will be void.**
2. Warranty is void if **all components** of the system are not original equipment supplied by the Manufacturer.
3. This product must be purchased from and installed by an authorized distributor or installer or a certified representative thereof **or the Warranty will be void.**
4. Malfunctions or failure resulting from misuse, abuse, negligence, alteration, accident, or lack of proper maintenance, or from lightning strikes, electrical power surges or interruption of electricity, shall not be considered defects under the Warranty.
5. This Warranty applies only to systems for the care of poultry and livestock. Other applications in industry, commerce, or residential applications are not covered by this Warranty and are **strictly prohibited.** Any such use **will void the Warranty.**

Manufacturer shall not be liable for any **Consequential or Special Damage** which any purchaser may suffer or claim to suffer as a result of any defect in the product. "**Consequential**" or "**Special Damages**" *as used herein include, but are not limited to, lost or damaged products or goods, costs of transportation, lost sales, lost orders, lost income, increased overhead, labor and incidental costs and operational inefficiencies.*

THIS WARRANTY CONSTITUTES THE MANUFACTURER'S ENTIRE AND SOLE WARRANTY AND THIS MANUFACTURER EXPRESSLY DISCLAIMS ANY AND ALL OTHER WARRANTIES, INCLUDING, BUT NOT LIMITED TO, EXPRESS AND IMPLIED WARRANTIES AS TO MERCHANTABILITY, FITNESS FOR PARTICULAR PURPOSES SOLD AND DESCRIPTION OR QUALITY OF THE PRODUCT FURNISHED HEREUNDER.

Distributors are not authorized to modify or extend the terms and conditions of this Warranty in any manner or to offer or grant any other warranties for the products in addition to those terms expressly stated above. An officer of the Manufacturer must authorize any exceptions to this Warranty in writing. Manufacturer reserves the right to change models and specifications at any time without notice or obligation to improve previous models.

Effective 01/07

