

48" and 52" Hyflo™ Un-Assembled Fans Assembly Manual

The employees of Chore-Time Equipment would like to thank you for your recent Chore-Time purchase. If a problem should arise, your Chore-Time distributor can supply the necessary information to help you.

Attaching the Posts

Lay the Shroud down with the Decal and the drain holes at the bottom as shown. Fasten the Posts (**Item 4**) to the Shroud (**Item 1**) with 5/16 Carriage Bolts and 5/16 Flange Nuts (**Items 5 and 6**) as shown.

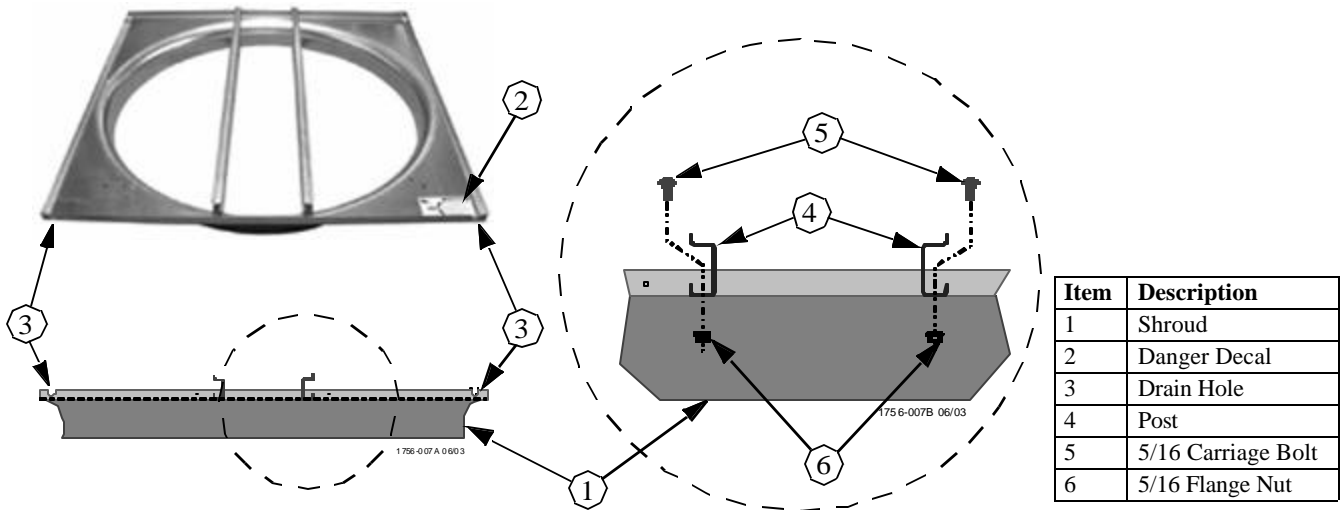

Attaching the Housing Panels

The Top and Bottom Panels have Tabs on them (**See Figure below**). The Bottom Panel does not have a Flange at the ends like the Top Panel (**See Figure below**). Attach the Bottom Panel to the bottom end of the Fan Shroud with four 1/4 x 1/2" Hex Washer Head Screws in the holes provided **as shown**. The bottom of the Fan Shroud is the end that has the Danger Decal.

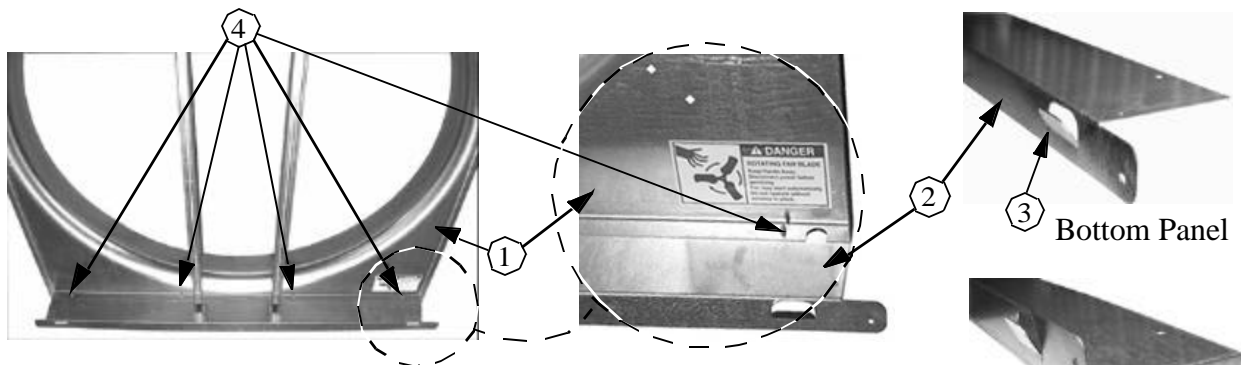

Item	Description	Item	Description
1	Shroud	3	Tab in Bottom Housing Panel
2	Bottom Housing Panel	4	1/4 x 1/2" Washer Head Screw

The Side Housing Panels can be distinguished from each other by the position of the Screen Clip Slot and mounting hole in the front of each Housing Panel (**Right Panel Shown, See Figure below**). Line up the Pre-drilled holes in the Side Housing Panels with the holes in the Shroud and attach them with four 1/4 x 1/2" Hex Washer Head Screws (**Item 4**). Attach the Left Side Housing Panel the same way..

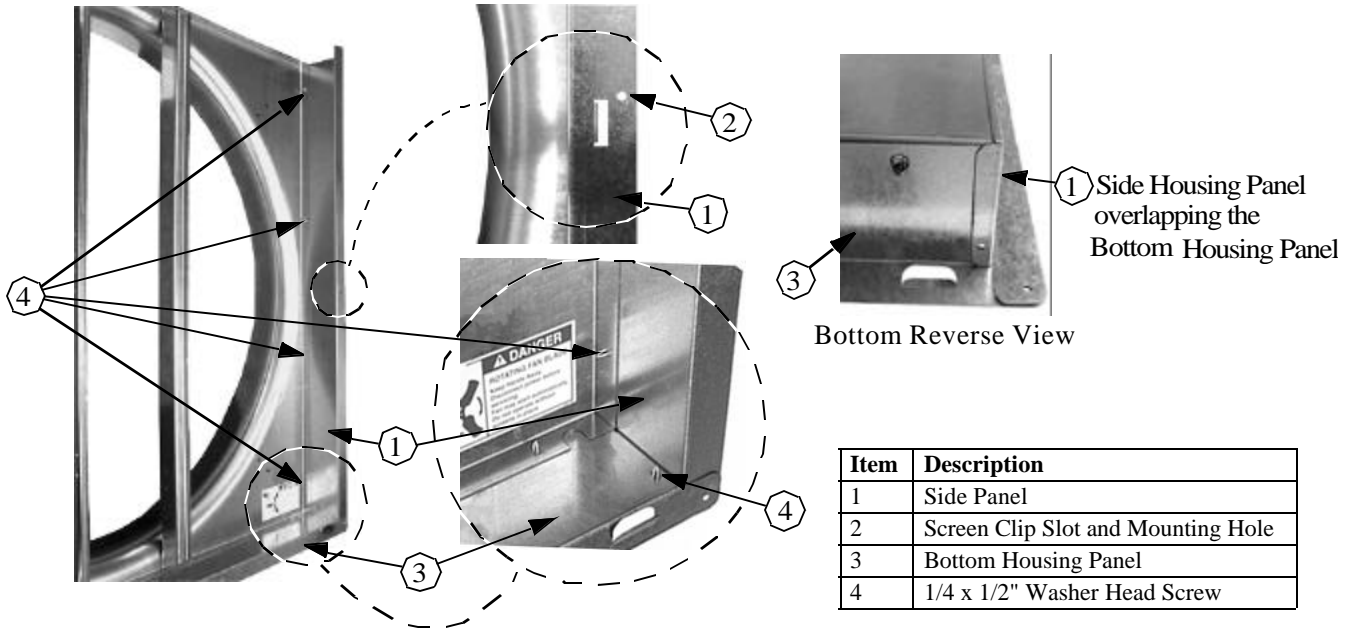

Item	Description
1	Side Panel
2	Screen Clip Slot and Mounting Hole
3	Bottom Housing Panel
4	1/4 x 1/2" Washer Head Screw

Attach the Top Housing Panel to the Shroud using the pre-drilled holes with four 1/4 x 1/2" Washer Head Screws. The Top Housing Panel should overlap the Side Housing Panels to provide water run-off. (See **Figure below**)

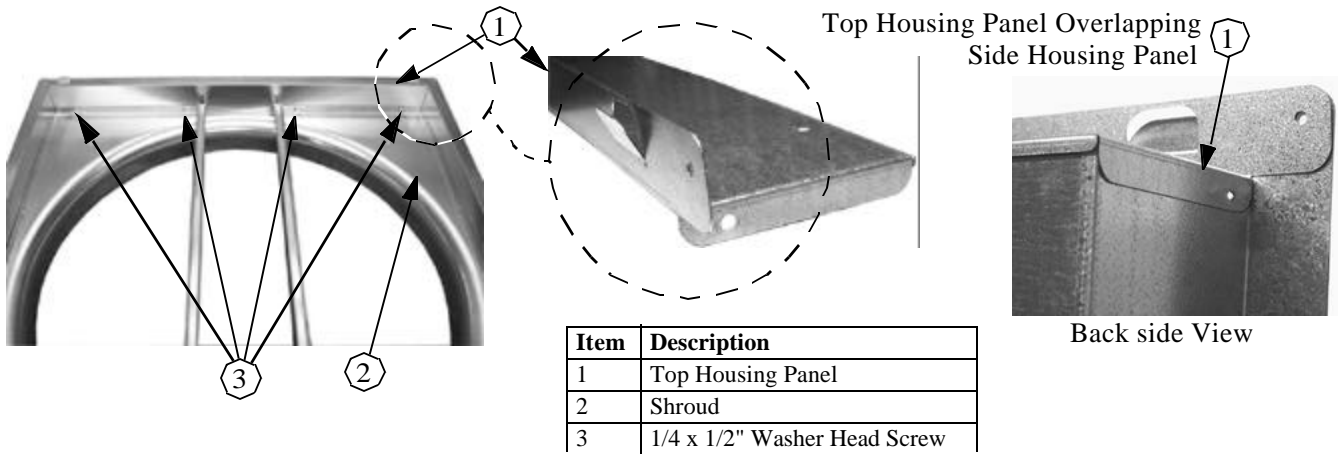

Item	Description
1	Top Housing Panel
2	Shroud
3	1/4 x 1/2" Washer Head Screw

Now that all four Housing Panels are attached to the Shroud, Use four 1/4 x 1/2" Hex Washer Head Screws to attach all four Housing Panels together using the pre-drilled holes at the four Corners. (See **Figure at right**).

Item	Description
1	Side Panel
2	1/4 x 1/2" Washer Head Screw
3	Bottom Housing Panel

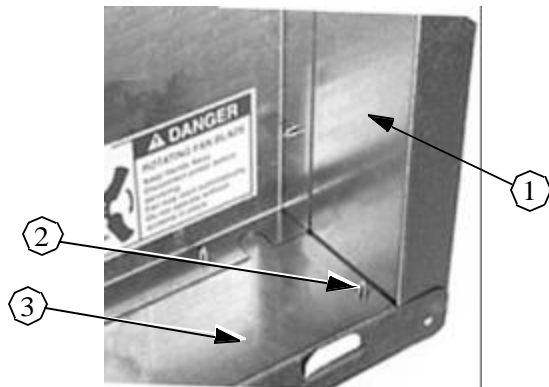

Installing Fan in the Wall

Set the Fan into the Wall opening and use the supplied 1/4 x 1-1/2" Lag Screws to attach the Fan to the Wall. Refer to the Hyflo Installation and Operation Manual ,MV1747 Page 2, for detailed attachment instructions.

Attaching the Idler and Motor Supports and Motor

Attach the Bearing Support Assembly (**Item 3**) to the Posts with 5/16 Carriage Bolts and Flange Nuts, (**Items 1 and 2**), using the bottom set of holes in the Posts. Attach the Motor Support, (**Item 4**), to the Posts with 5/16 Carriage Bolts and Flange Nuts. Check that both the Bearing Support and the Motor Support are perpendicular to the Posts. Rotate the Belt Tensioner until the centerline on the Tensioner Assembly lines up with the Mark on the Tensioner Bracket and Tighten the 3/8 Bolt (**Item 6**) on the back of the Tensioner Assembly. Attach the Motor to the Motor Support Bracket with 5/16 Carriage Bolts and Flange Nuts.

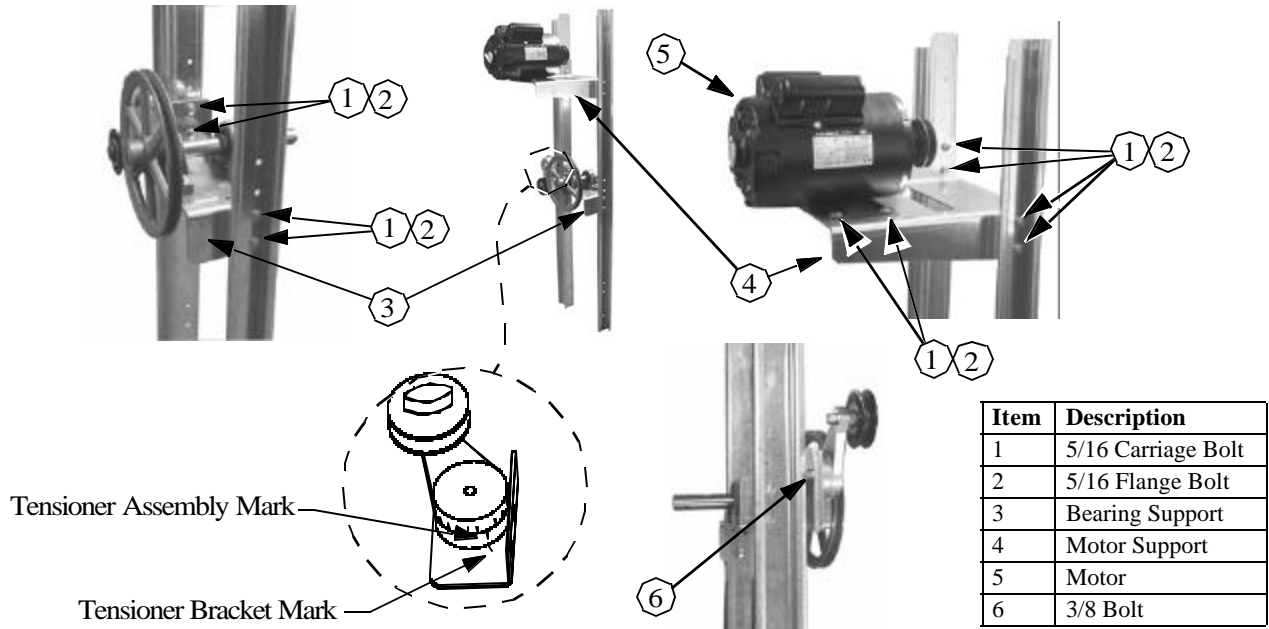

Blade Installation

Apply Anti-Seize (**Included in Parts Package**) to the Fan Shaft as shown below. Insert the 1/4 x 1-1/8 Square Key supplied, and put on the Blade. Position the Blade flush with the end of the Fan Shaft and torque the Blade Set Screws to 150-165 IN-LBS.

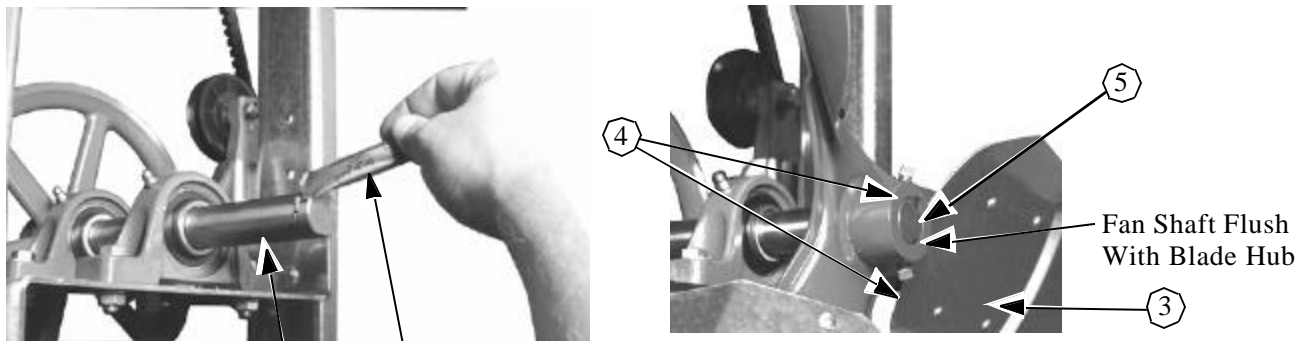

Item	Description
1	Anti-Seize
2	Fan Shaft
3	Blade
4	Blade Set Screws
5	1/4 x 1-1/8 Square Key

Assembling the Inlet Screen

With the Inlet Screen Laying flat rotate the Screen Sides 90 degrees and secure with supplied Nylon Cable Ties. Use two Nylon Cable Ties per Corner in the locations **shown below**. Trim off excess Cable tie. (**Cable ties shown before being cut off for clarity**).

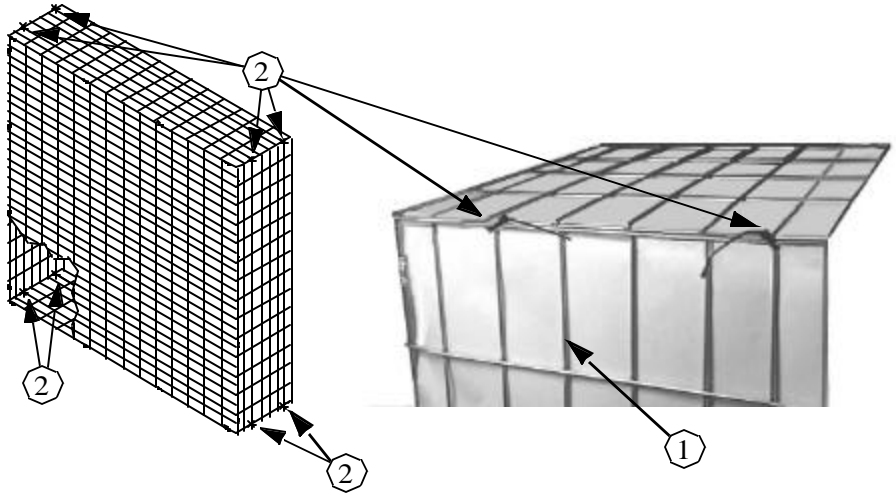

Item	Description
1	Screen Side
2	Nylon Cable Tie

Refer to the Hyflo Installation and Operators Manual MV1747 for further installation procedures.



**Made to work.
Built to last.**

Contact your nearby Chore-Time distributor or representative for additional parts and information.
CTB Inc.

P.O. Box 2000 • Milford, Indiana 46542-2000 • U.S.A.
Phone (574) 658-4101 • Fax (877) 730-8825
E-Mail: ctb@ctbinc.com • Internet: <http://www.ctbinc.com>

Printed in the U.S.A.